

Общество с ограниченной ответственностью
«Научно-производственное предприятие «Техно-ПАРК»
(ООО «НПП «Техно-ПАРК»)

Тел/факс (495) 411-96-09

Юридический и фактический адрес: 121357, г. Москва, ул. Верейская, д. 29, стр. 135.

Почтовый адрес для переписки: 121357 Москва, а/я 61.

E-mail: mail@sawtechno.ru

Web: www.sawtechno.ru

Технические характеристики генератора, управляемого напряжением

ТХ0406А

Производитель: TAI-SAW TECHNOLOGY CO., LTD

Поставщик: ООО «НПП «Техно-ПАРК» - авторизованный дистрибьютор компании
TAI-SAW TECHNOLOGY CO., LTD

Научно-производственное предприятие ООО «НПП «Техно-ПАРК» разрабатывает и поставляет полосно-пропускающие радиочастотные фильтры на поверхностных акустических волнах (ПАВ) и устройства на их основе. «НПП «Техно-ПАРК» имеет собственную научную и производственную базу, а также является авторизованным дистрибьютором мирового лидера по производству фильтров на ПАВ компании TAI-SAW TECHNOLOGY CO., LTD

E-mail: mail@sawtechno.ru Web: www.sawtechno.ru



TAI-SAW TECHNOLOGY CO., LTD.

No. 3, Industrial 2nd Rd., Ping-Chen Industrial District,
Taoyuan, 324, Taiwan, R.O.C.

TEL: 886-3-4690038 FAX: 886-3-4697532

E-mail: tstsales@mail.taisaw.com Web: www.taisaw.com

Product Specifications Approval Sheet

Product Description: VCTCXO SMD 5.0x3.2 14.7456MHz

TST Part No.: TX0406A

Customer Part No.: _____

Customer signature required
Company: _____
Division: _____
Approved by : _____
Date: _____

Checked by: _____ Ginger Huang *Ginger Huang*

Approved by: _____ Kelly Huang *Kelly Huang*

Date: _____ 05/12/2010

1. Customer signed back is required before TST can proceed with sample build and receive orders.
2. Orders received without customer signed back will be regarded as agreement on the specifications.
3. Any specifications changes must be approved upon by both parties and a new revision of specifications shall be released to reflect the changes.



TAI-SAW TECHNOLOGY CO., LTD.
SMD 5.0x3.2 14.7456MHz VCTCXO

MODEL NO.: TX0406A

REV. NO.: 1.0

Revise:

Rev.	Rev. Page	Rev. Account	Date	Ref. No.	Reviser
1	N/A	Initial release	05/12/10'	N/A	Ginger Huang



TAI-SAW TECHNOLOGY CO., LTD.

No. 3, Industrial 2nd Rd., Ping-Chen Industrial District,
Taoyuan, 324, Taiwan, R.O.C.

SMD 5.0x3.2 14.7456MHz VCTCXO

MODEL NO.:TX0406A

REV. NO.: 1.0

Features:

- Miniature SMD Package
- Good Frequency Stability
- Good Phase Noise Response

RoHS Compliant
Lead free
Lead-free soldering

Description and Applications:

Surface mount 5.0mmx3.2mm VCTCXO for wireless communication system.

Electrical Specifications:

TX0406A	Specifications
Nominal Frequency, Fo	14.7456 MHz
Storage Temperature Range	-40°C to +85°C
Operating Temperature Range	-30°C to +75°C
Power Supply Voltage, Vcc	3.3 V
Output Waveform	Clipped Sine wave
Output Voltage with Load 10pF//10KΩ, Vout	0.8 Vp-p min
Power Supply Current, Icc	1.5 mA max
Control Voltage, Vcon	1.50 +/- 1.0 V
Frequency Tolerance (Vcon=1.5V) after Reflow	+/- 2.5 ppm max @ 25°C +/- 2°C
Frequency Stability a. Vs. Temperature (-30~75°C) b. Vs. Supply Voltage varied 3.3V+/-5% c. Vs. Load varied +/-10%	+/- 2.5 ppm +/- 0.3 ppm +/- 0.2 ppm
Vcon Frequency Control Range (1.50+/-1.0 V)	+/-9ppm to +/-15ppm/V
Start Up Time (90% of final RF level in Vp-p)	3.5 msec max.
Aging	+/-1.0 ppm/year @25°C+/-3°C
Marking	Laser Marking

Mechanical Dimensions (mm):

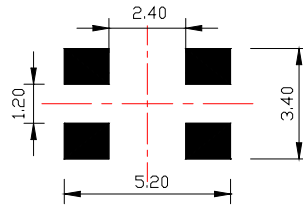
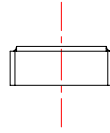
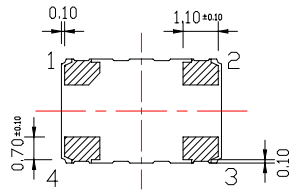
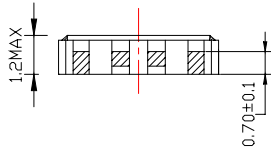
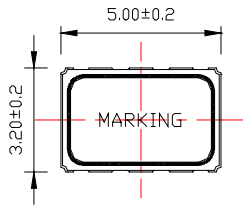

Recommended Soldering Pattern

UNIT: mm

PIN	FUNCTION
1	VCON: VCTCXO GND: TCXO Tri-state:XO
2	GND
3	OUT
4	VDD

Marking:

Line 1: Frequency

Line 2: TST Logo + Product code + Date Code + Traceability Code (XX)

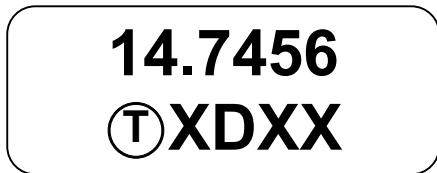

Product Code Table

Year	2009	2010	2011	2012
	2013	2014	2015	2016
Product Code	X	x	X	x

Date Code Table

WK01	WK02	WK03	WK04	WK05	WK06	WK07	WK08	WK09	WK10	WK11	WK12	WK13
A	B	C	D	E	F	G	H	I	J	K	L	M
WK14	WK15	WK16	WK17	WK18	WK19	WK20	WK21	WK22	WK23	WK24	WK25	WK26
N	O	P	Q	R	S	T	U	V	W	X	Y	Z
WK27	WK28	WK29	WK30	WK31	WK32	WK33	WK34	WK35	WK36	WK37	WK38	WK39
a	b	c	d	e	f	g	h	i	j	k	l	m
WK40	WK41	WK42	WK43	WK44	WK45	WK46	WK47	WK48	WK49	WK50	WK51	WK52
n	o	p	q	r	s	t	u	v	w	x	y	z

Packing (mm):

1. Reel Dimension

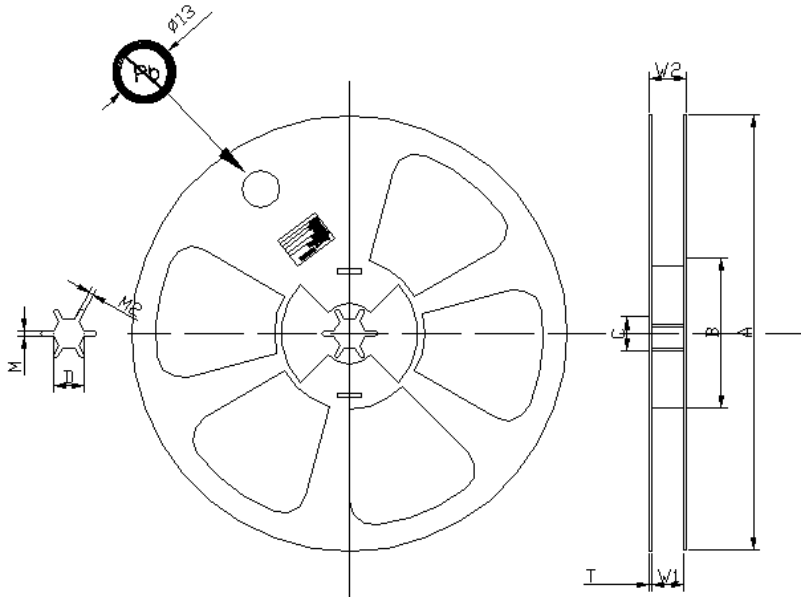

Unit:mm	A	B	C	D	T	M	M2	W1	W2
Dimension	180	62	21	13	2.05	2.50	2.00	12.4	16.5
Tolerance	± 0.1	± 0.5	± 0.1	± 0.5	± 0.5	± 0.5	± 0.2	+1.0/-0.0	± 0.2

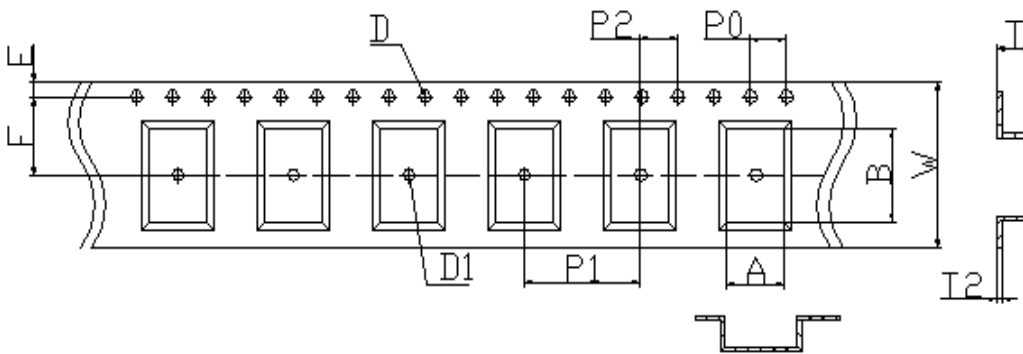

2. Tape Dimension

	A	B	D	D1	E	F	P0	P1	P2	T	T2	W
Dimension	3.81	5.74	1.50	1.50	1.75	5.50	4.00	8.00	2.00	2.24	0.292	12.00
Tolerance	± 0.1	± 0.1	+0.1	+0.1	± 0.1	± 0.1	± 0.1	± 0.1	± 0.05	± 0.1	± 0.05	+0.3/-0.1

Reflow Profile:

