



TAI-SAW TECHNOLOGY CO., LTD.

No. 3, Industrial 2nd Rd., Ping-Chen Industrial District,
Taoyuan, 324, Taiwan, R.O.C.

Product Specifications Approval Sheet

Product Description: SAW DPX 707.5/ 737.5 MHz LTE Band 12 SMD 1814

TST Part No.: TF0133AN

Customer Part No.: _____

Customer signature required
Company: _____
Division: _____
Approved by : _____
Date: _____

Checked by: _____ Anne Chen *Anne Chen*

Approved by: _____ Andy Yu *Andy Yu*

Date: _____ 2017/12/22

1. Customer signed back is required before TST can proceed with sample build and receive orders.
2. Orders received without customer signed back will be regarded as agreement on the specifications.
3. Any specifications changes must be approved upon by both parties and a new revision of specifications shall be released to reflect the change



TAI-SAW TECHNOLOGY CO., LTD.

No. 3, Industrial 2nd Rd., Ping-Chen Industrial District,
Taoyuan, 324, Taiwan, R.O.C.

SAW DPX 707.5/737.5 MHz LTE Band 12 SMD 1814 (17 MHz BW)

MODEL NO.:TF0133AN

REV.No.:1

A. MAXIMUM RATING:

1. Operating temperature range: -30 °C to +85 °C
2. Storage temperature range: -30 °C to +85 °C
3. Tx Input power : 29dBm (Ta=+50°C,50000h)
- 3.1Rx Input power : 15dBm (Ta=+50°C,50kh,CW)
4. Maximum DC Voltage: +/-3 V
5. Moisture Sensitivity Level: Level 1 (MSL 1)
6. ESD 100V(MM) 200V(HBM)

RoHS Compliant

Lead-free soldering

Electrostatic Sensitive Device (ESD)

B. ELECTRICAL CHARACTERISTICS:

Terminating impedance (Tx Port): 50 Ω (Single-ended)

Terminating impedance (Rx Port): 50 Ω (Single-ended)

Terminating impedance (Ant Port): 50//12nH Ω (Single-ended)

Tx to ANT (f_{T0}=707.5 MHz)

Parameters Description		Unit	Min	Typ	Max	Remarks
Insertion Loss(*1)	699~716MHz	dB	-	1.65	2.35	
Amplitude ripple	699~716MHz	dB	-	0.8	1.5	
VSWR	ANT	699~716MHz	-	1.8	2.1	
	Tx	699~716MHz	-	1.9	2.2	
Attenuation:						
729 ~ 746 MHz		dB	45	54	-	
746 ~ 768 MHz		dB	30	46	-	
768 ~ 805 MHz		dB	25	41	-	
869 ~ 894 MHz		dB	35	44	-	
1398 ~ 1432 MHz		dB	30	46		
1559 ~ 1606 MHz		dB	40	46	-	
2097 ~ 2155 MHz		dB	35	43	-	
2400 ~ 2484 MHz		dB	30	55	-	
2796 ~ 2864 MHz		dB	15	41	-	
4900 ~ 5850 MHz		dB	5	12		

ANT to Rx (f_{T0}=737.5 MHz)

Parameters Description		Unit	Min	Typ	Max	Remarks
Insertion Loss	729 ~ 746 MHz	dB	-	1.65	2.35	
Amplitude ripple	729 ~ 746 MHz	dB	-	0.5	1.5	
VSWR	ANT	-		1.6	2.0	
	Rx			1.9	2.2	
Attenuation:						
699 ~ 716 MHz		dB	55	62	-	
776 ~ 805 MHz		dB	35	40	-	
814 ~ 960 MHz		dB	40	55		
1710 ~ 1755 MHz		dB	40	54		
1850 ~ 1920 MHz		dB	40	52	-	
2187 ~ 2238 MHz		dB	40	51	-	
2400 ~ 2500 MHz		dB	40	49		
4900 ~ 5950 MHz		dB	35	46		

Tx to Rx

Isolation	699 ~ 716 MHz	dB	60	63	-	
	729 ~ 746 MHz	dB	55	58	-	

(*1) Specification of insertion loss excludes loss that comes from the test board.

C. FREQUENCY CHARACTERISTICS:

Tx to Ant

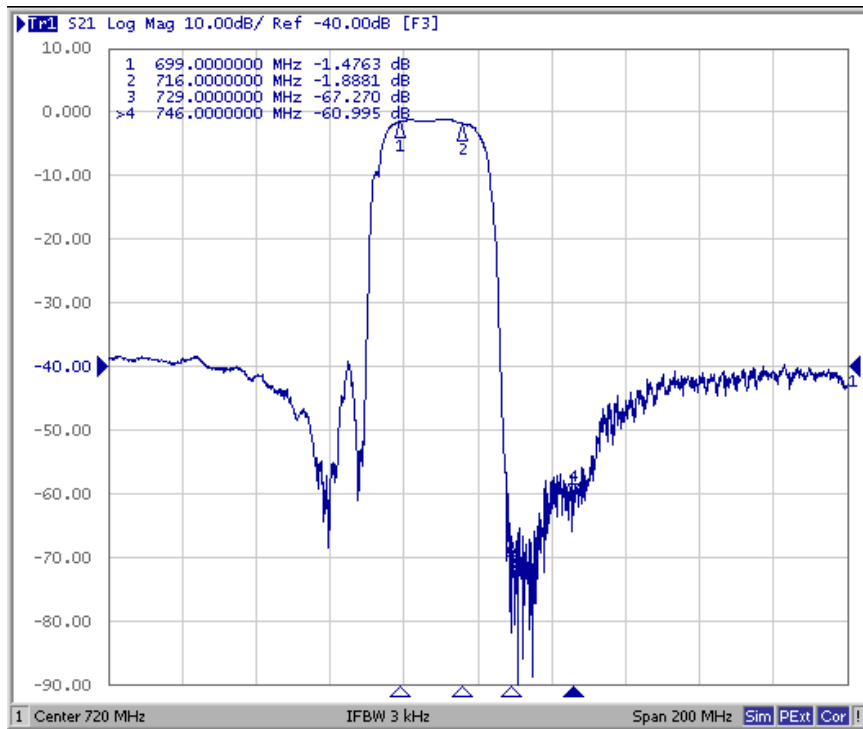

Ant to Rx

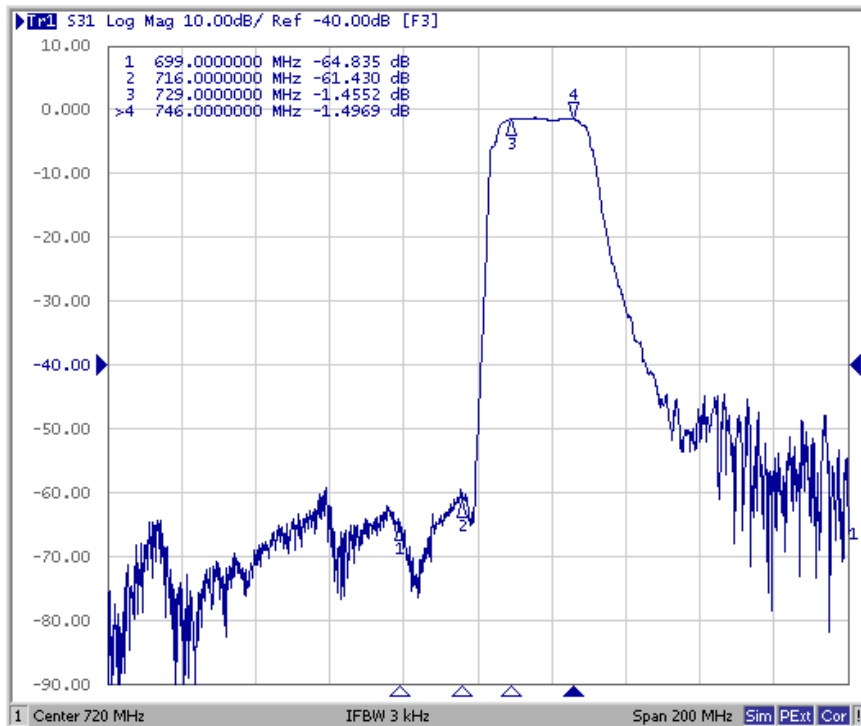

These data exclude loss that comes from the test board

Tx to Ant, Ant to Rx

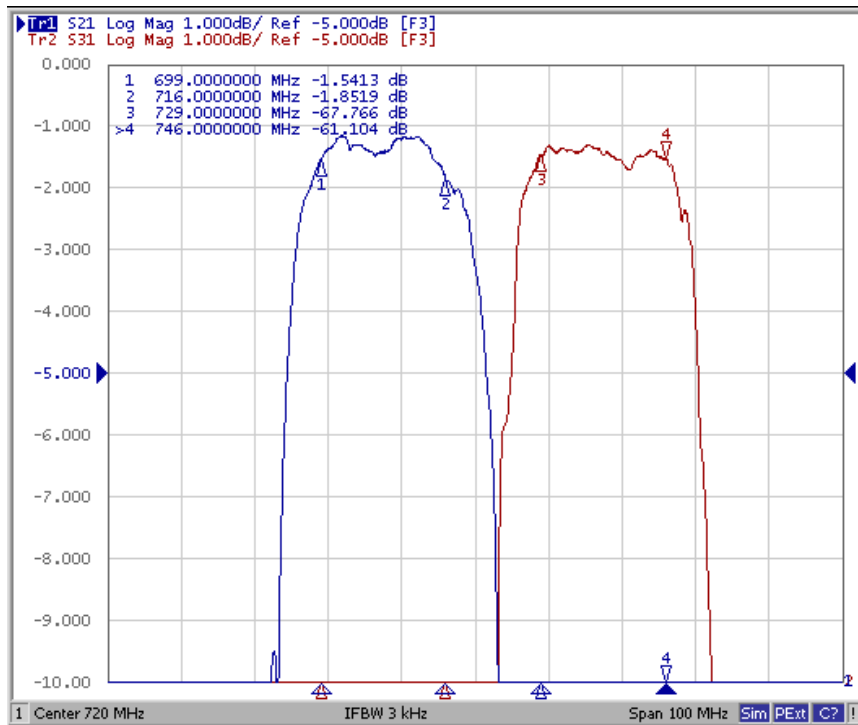

Tx to Rx Isolation

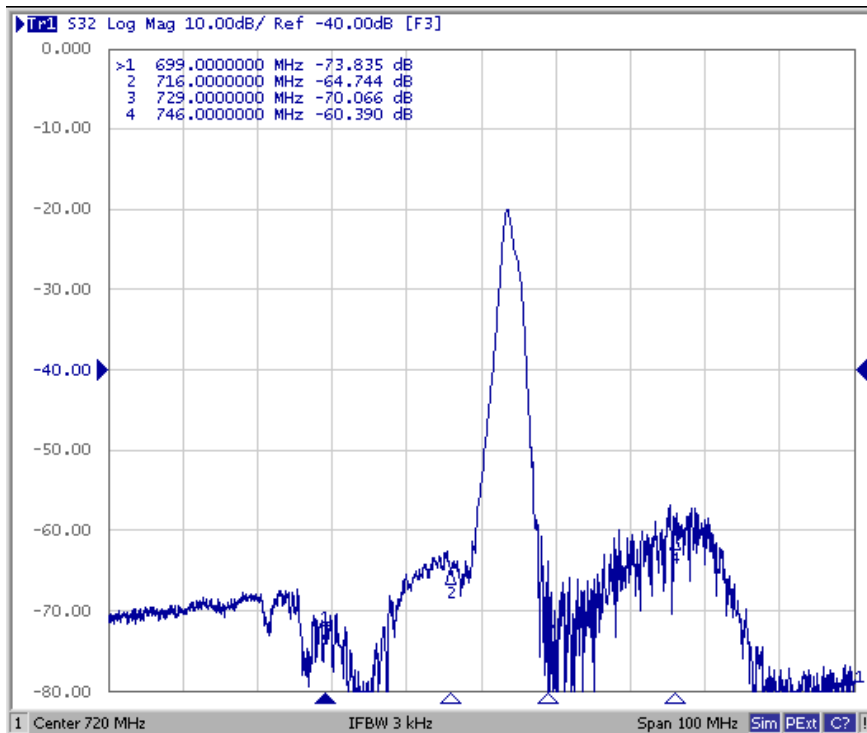

These data exclude loss that comes from the test board.

Tx Port

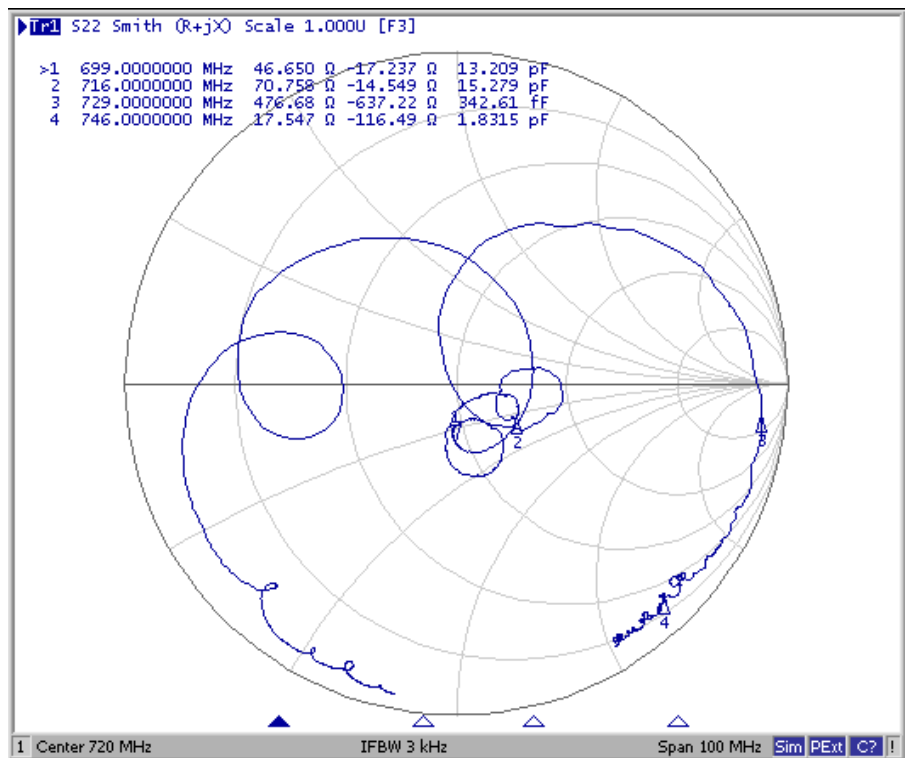
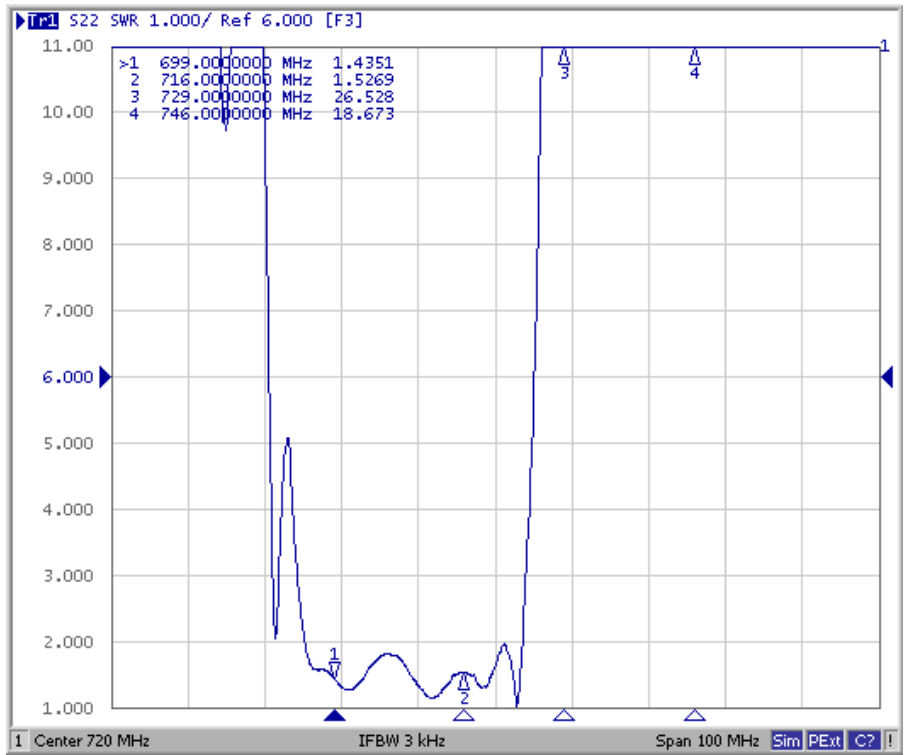

Rx Port

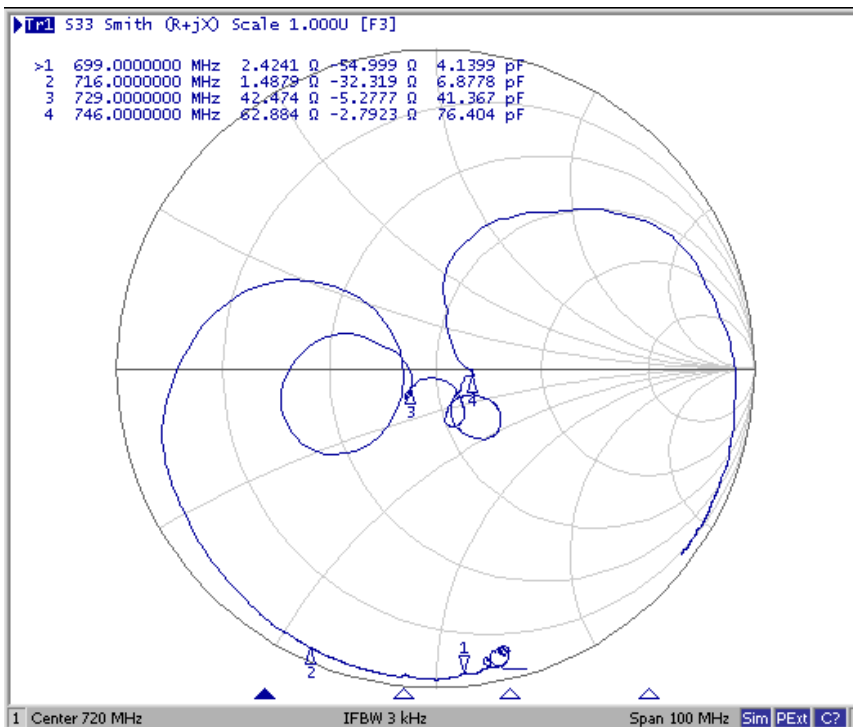
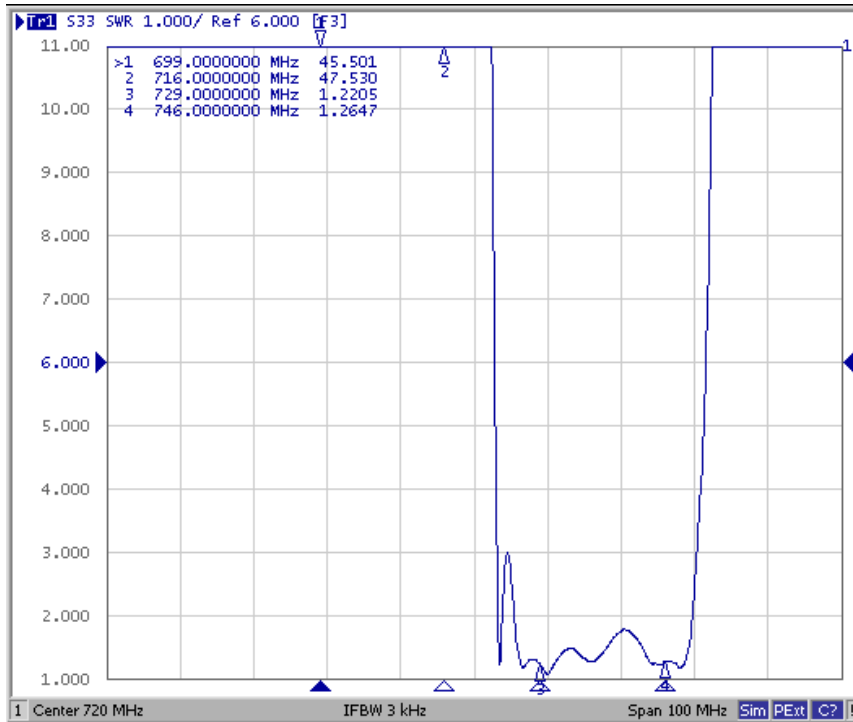

Ant Port

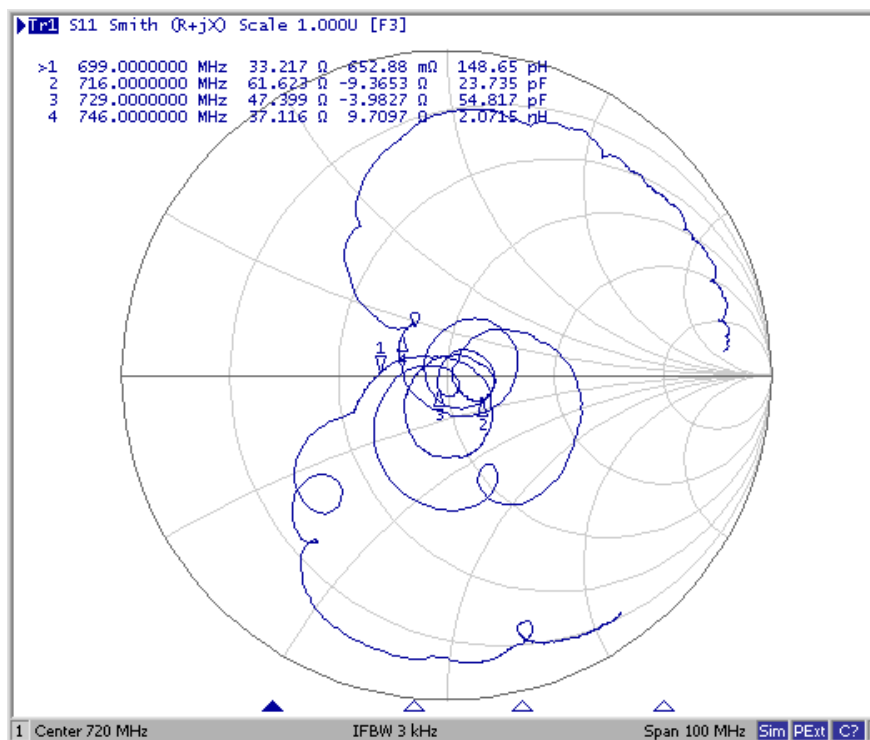
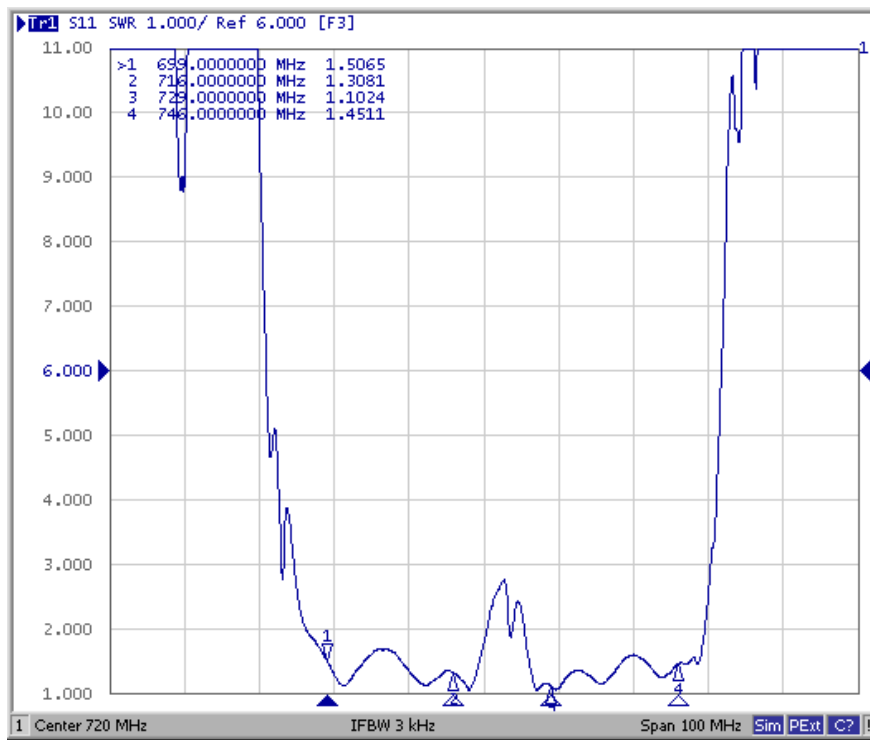

Tx to Ant (Wide Span)

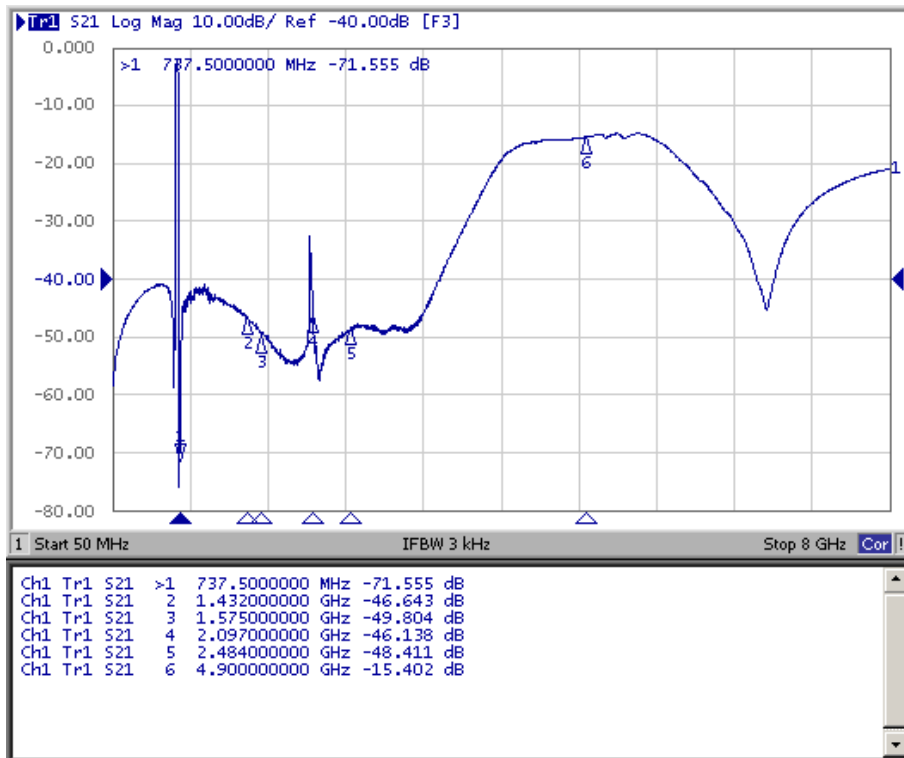

Ant to Rx (Wide Span)

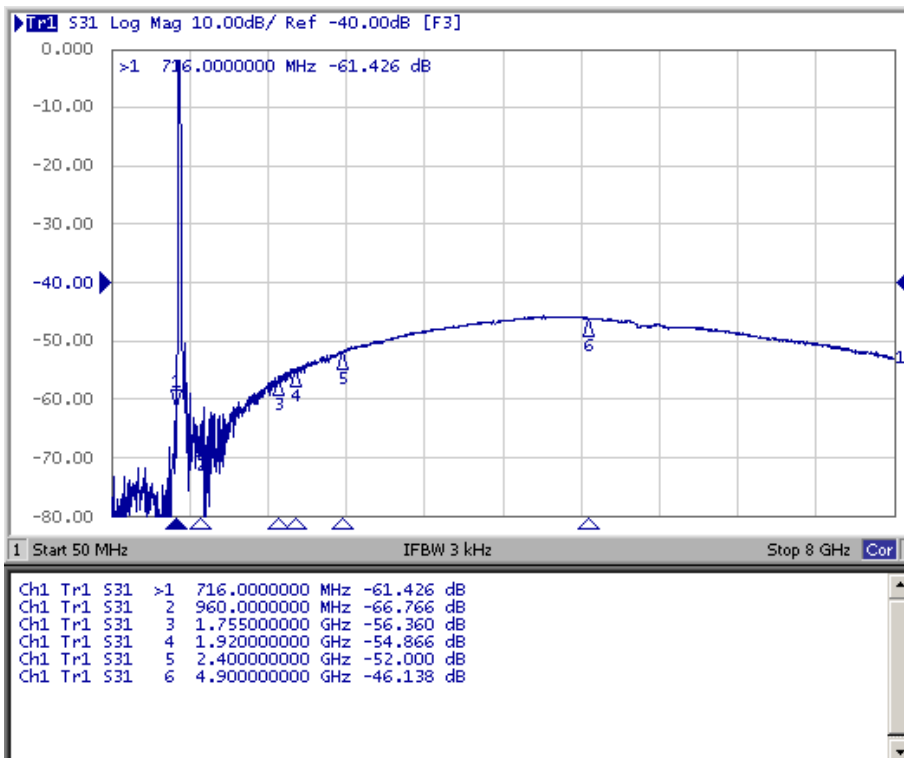

D. OUTLINE DRAWIN(Mass Production):

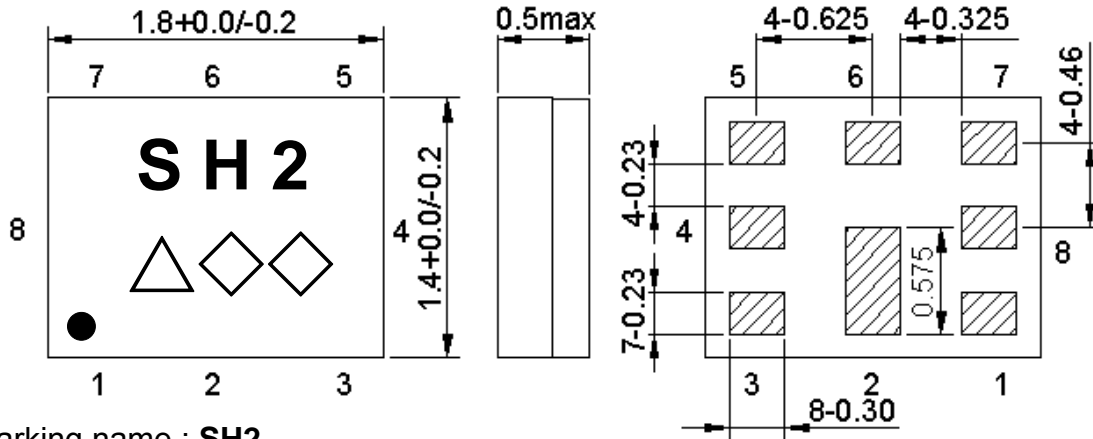

Marking name : **SH2**

△: Date code(2016 May → s ,....., 2019 Dec→m.)

◇◇: Lot Code.

Product Date Code. Follow below table.

Year	Jan	Feb	Mar	Apr	May	Jun	Jul	Aug	Sep	Oct	Nov	Dec
2016	n	p	q	r	s	t	u	v	w	x	y	z
2017	A	B	C	D	E	F	G	H	J	K	L	M
2018	N	P	Q	R	S	T	U	V	W	X	Y	Z
2019	a	b	c	d	e	f	g	h	j	k	l	m

Pin Configuration:

Pin No.	Pin Name	Description
1	Rx	Receive Pin
2	GND	Ground Pin
3	Tx	Transmitter Pin
4	GND	Ground Pin
5	GND	Ground Pin
6	ANT	Antenna Pin
7	GND	Ground Pin
8	GND	Ground Pin

E. FOOTPRINT:

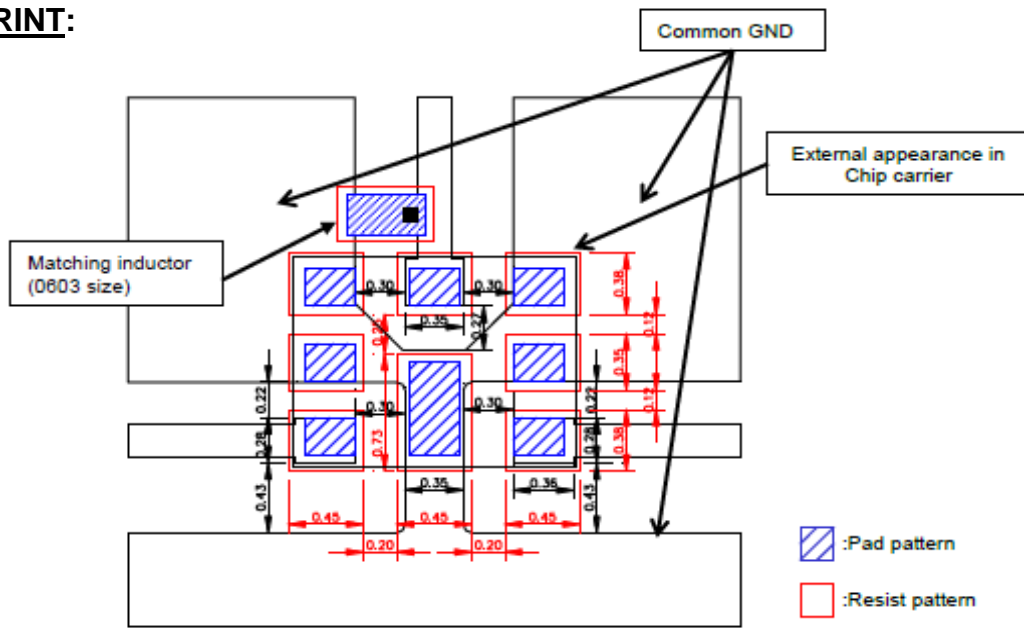

F. Evaluation Circuit

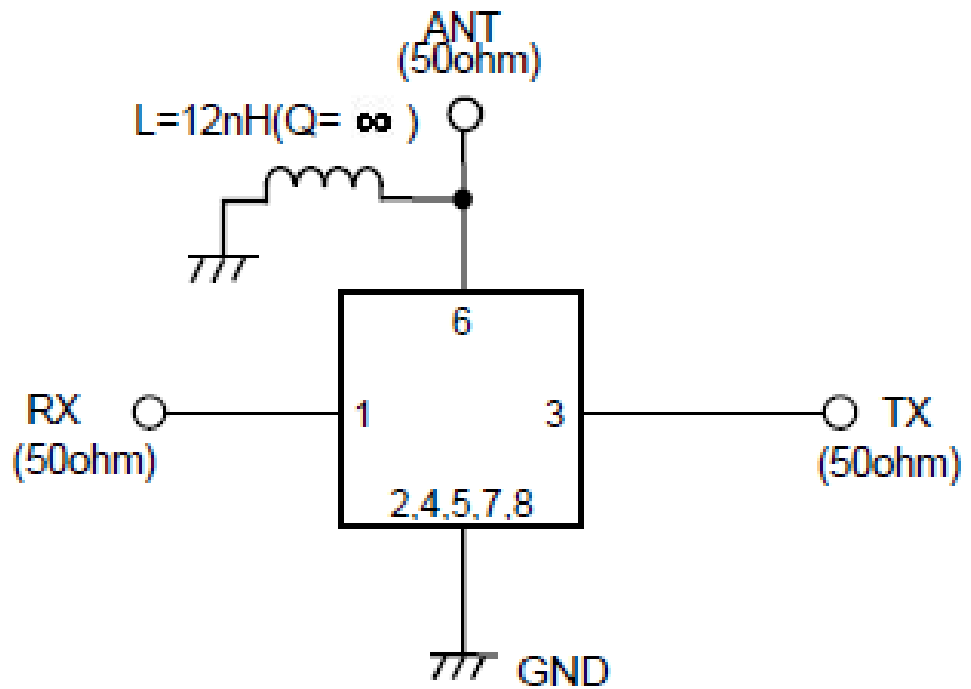

G. PACKING:

1. REEL DIMENSION

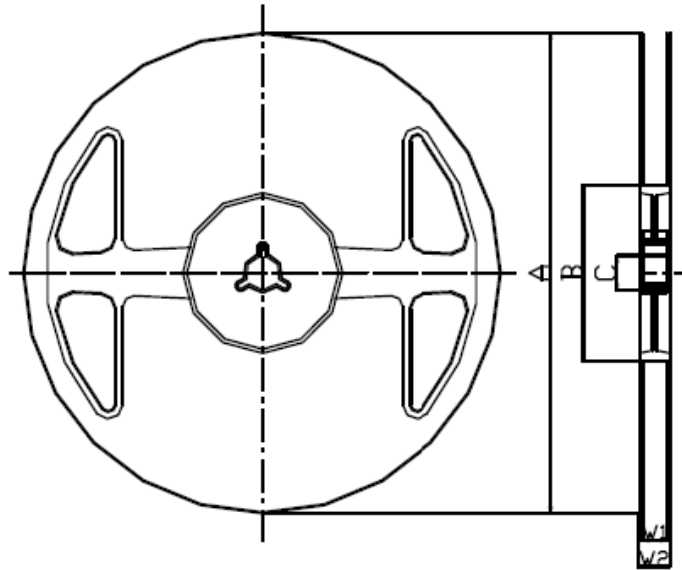

Materials of Reel

Material : Polystyrene + Carbon

Characteristics : Conforms to EIAJ-ET-7200A

Color : Black

Surface resistance (reference value) : $10^9\Omega/\text{sq}$ Max.

Unit : mm

Code	Quantity	A	B	C	W1	W2
Z	3,000 pcs	$\phi 180.0 +0.0/-1.5$	$\phi 66.0 +/-0.5$	$\phi 13.0 +/-0.2$	$9.0 +1.0/-0.0$	$11.4 +/-1.0$

2. TAPE DIMENSION

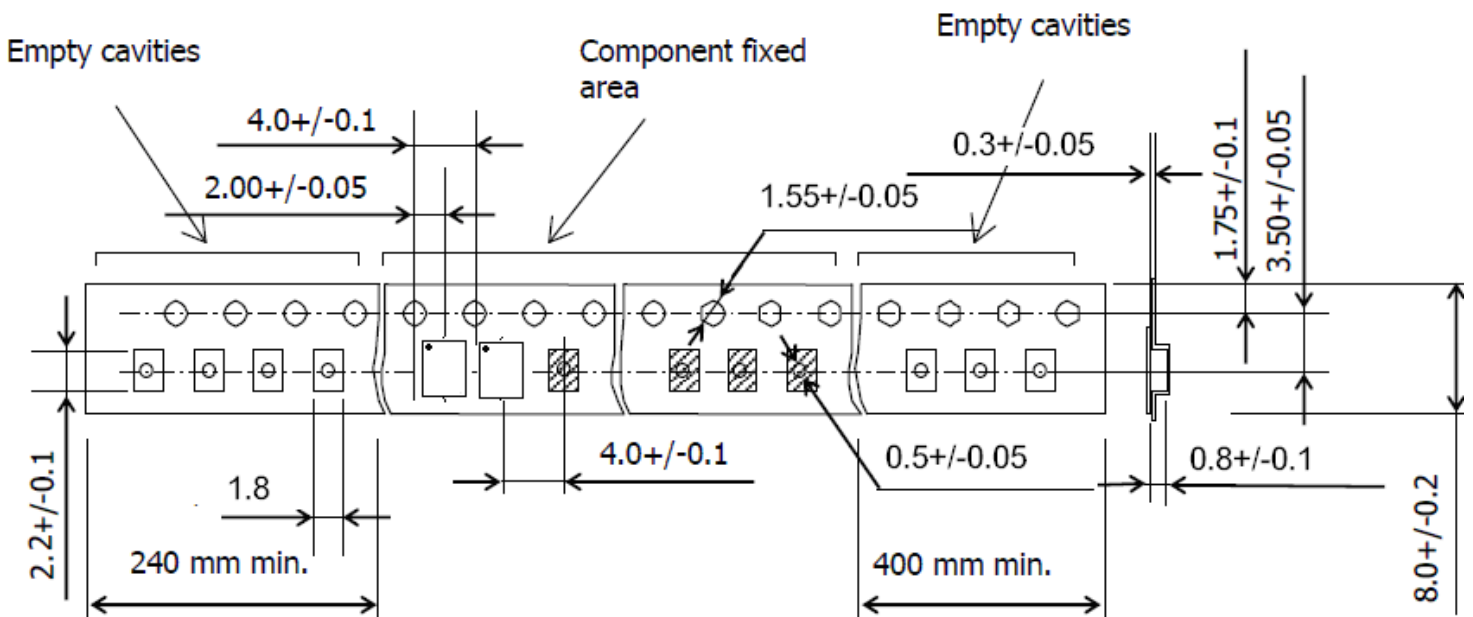

Unit : mm

Direction of feed

H. RECOMMENDED REFLOW PROFILE :

1. Preheating shall be fixed at 150~180°C for 60~90 seconds.
2. Ascending time to preheating temperature 150°C shall be 30 seconds min.
3. Heating shall be fixed at 220°C for 50~80 seconds and at 245~260°C peak (min. 10sec).
4. Time : 2 times.

