



# TAI-SAW TECHNOLOGY CO., LTD.

No. 3, Industrial 2nd Rd., Ping-Chen Industrial District,  
Taoyuan, 324, Taiwan, R.O.C.

## Product Specifications Approval Sheet

Product Description: SAW DPX 897.5/942.5 MHz Band 8 SMD 1.8X1.4 mm (BW=30.2 MHz)

TST Part No.: TF0130B

Customer Part No.: \_\_\_\_\_

Customer signature required
Company: _____
Division: _____
Approved by : _____
Date: _____

Checked by: \_\_\_\_\_ Anne Chen *Anne Chen*

Approved by: \_\_\_\_\_ Andy Yu *Andy Yu*

Date: \_\_\_\_\_ 2018, 12, 25

1. Customer signed back is required before TST can proceed with sample build and receive orders.
2. Orders received without customer signed back will be regarded as agreement on the specifications.
3. Any specifications changes must be approved upon by both parties and a new revision of specifications shall be released to reflect the change



# TAI-SAW TECHNOLOGY CO., LTD.

No. 3, Industrial 2nd Rd., Ping-Chen Industrial District,  
Taoyuan, 324, Taiwan, R.O.C.

SAW DPX 897.5/942.5 MHz Band 8 SMD 1.8X1.4 mm (BW=30.2 MHz)

MODEL NO.:TF0130B

REV.1.0

## A. MAXIMUM RATING:

1. Operating temperature range: -30 °C to +85 °C
2. Storage temperature range: -30 °C to +85 °C
3. Input power : 29dB (Ta=+50 °C,10000h,WCDMA modulation )
4. Maximum DC Voltage: +/-3 V
5. Moisture Sensitivity Level: Level 1 (MSL 1)
6. ESD 100V(MM) 200V(HBM)

RoHS Compliant  
Lead free  
Lead-free soldering

Electrostatic Sensitive Device (ESD)

## B. ELECTRICAL CHARACTERISTICS:

Terminating impedance (Tx Port): 50 Ω(Single-ended)

Terminating impedance (Rx Port): 100 Ω (Differential)

Terminating impedance (Ant Port): 50//7.5nH Ω(Q=∞) (Single-ended)

### Tx to ANT (f<sub>T0</sub>=897.5 MHz)

Parameters		Description	Unit	Min	Typ	Max	Remarks
Insertion Loss		882.4~912.6MHz	dB(*1)	-	1.5	2.4(*2)	
		880~915MHz	dB(*1)		1.9	3.4	
Amplitude ripple		882.4~912.6MHz	dB	-	0.6	1.9	
		880~915MHz	v		1.0	2.9	
VSWR	ANT	880~915MHz	-	-	2.0	2.6	
	Tx	880~915MHz	-	-	1.8	2.4	
<b>Attenuation:</b>							
927.4~957.6 MHz			dB	42(*2)	47	-	
1573.3~1605.9 MHz			dB	40	45	-	
1760~1830 MHz			dB	40	45	-	
2640~2745 MHz			dB	25	32	-	

### ANT to Rx ( $f_{T0}=942.5$ MHz)

Parameters Description		Unit	Min	Typ	Max	Remarks
Insertion Loss	927.4~957.6 MHz	dB(*1)	-	1.9	2.4(*2)	
	925~960 MHz	dB(*1)		2.1	3.1	
Amplitude ripple	927.4~957.6 MHz	dB	-	0.7	1.6	
	925~960 MHz	dB		0.9	2.3	
Amplitude balance	925~960 MHz	dB	-0.7	-0.1/+0.3	+0.7	
Phase balance	925~960 MHz	dB	-7	-1/+3	+7	
VSWR	ANT	-		1.9	2.3	
	Rx	-		2.0	2.4	
<b>Attenuation:</b>						
882.4~912.6 MHz		dB	48 (*2)	54	-	
2400~2500 MHz		dB	40	49	-	

### Tx to Rx

Isolation	882.4~912.6MHz	dB	52(*2)	56	-	
	927.4~957.6 MHz	dB	47 (*2)	51	-	

(\*1) Specification of insertion loss excludes loss that comes from the test board.

(\*2) Integrated over +/-1.92MHz around the WCDMA channel center frequency

### C.Evaluation Circuit

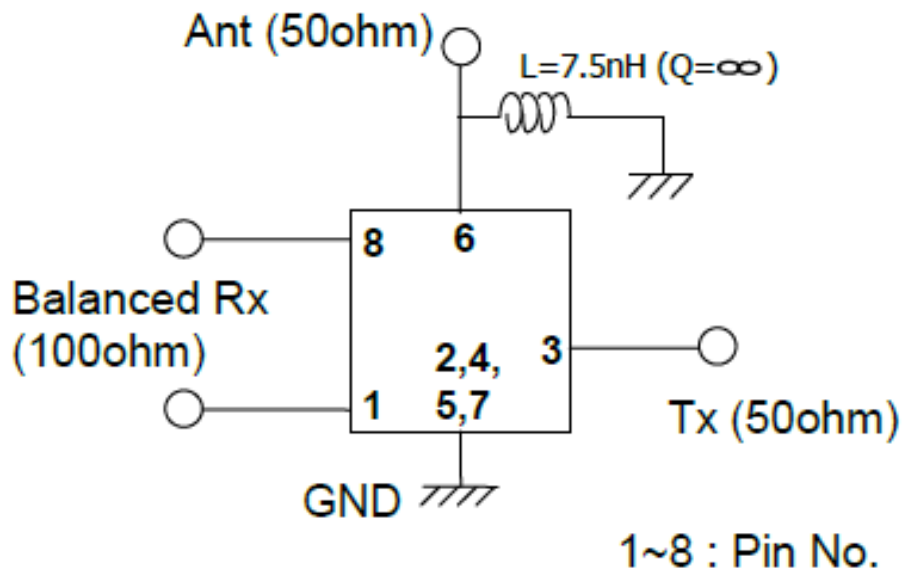

**Figure 2. Evaluation Circuit**

## D. FREQUENCY CHARACTERISTICS:

### Tx to Ant

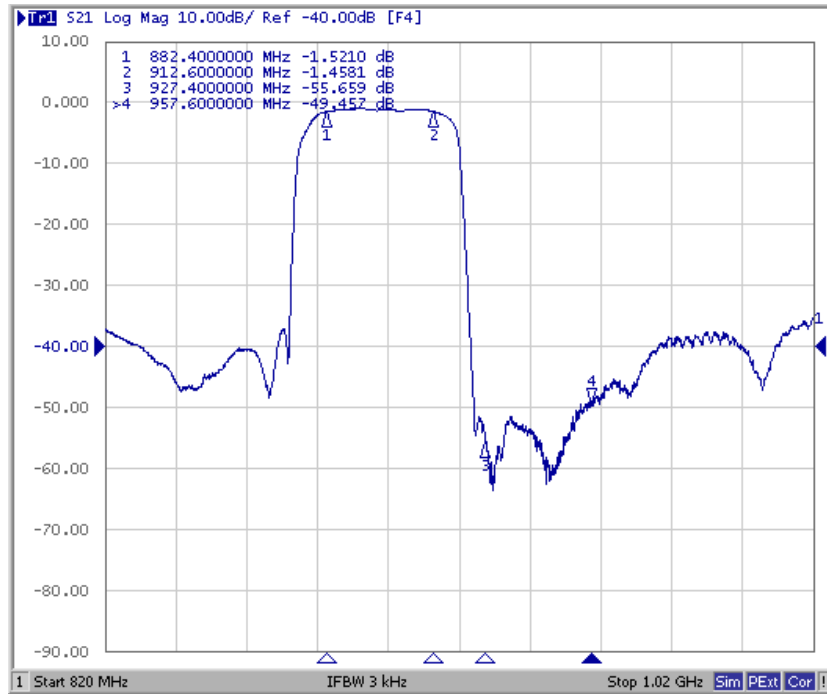

### Ant to Rx

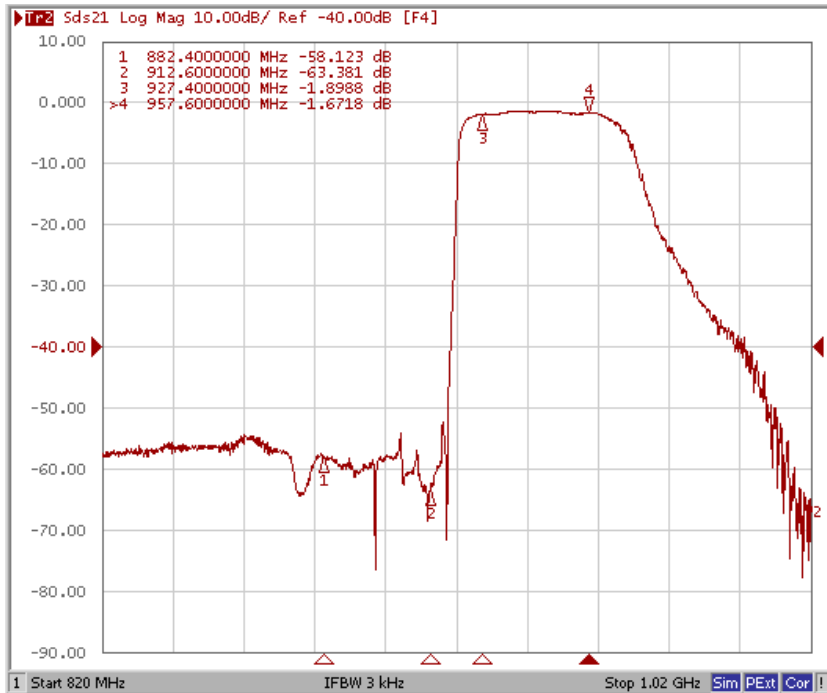

These data **exclude** loss that comes from the test board.

## Tx to Ant ,Ant to Rx

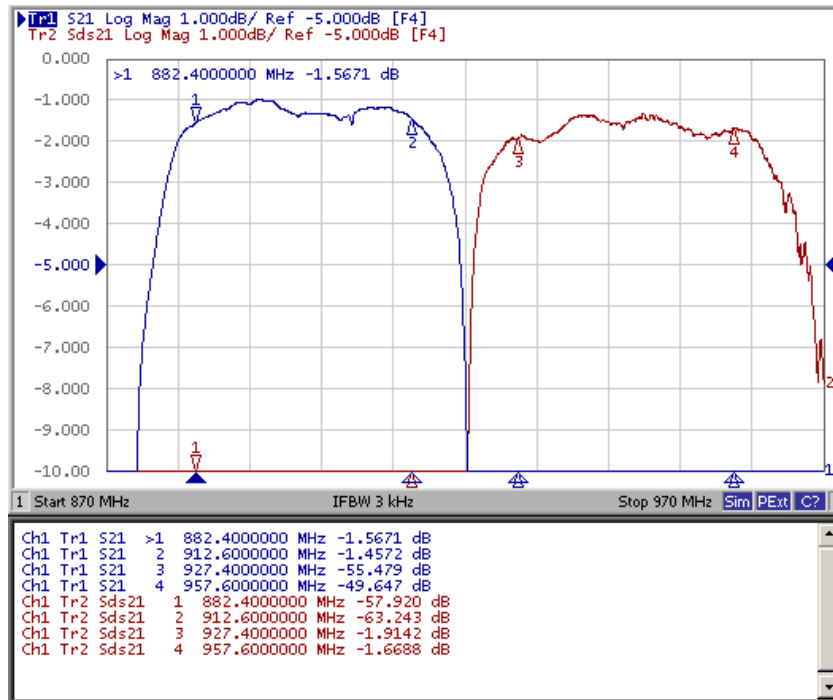

## Tx to Rx Isolation

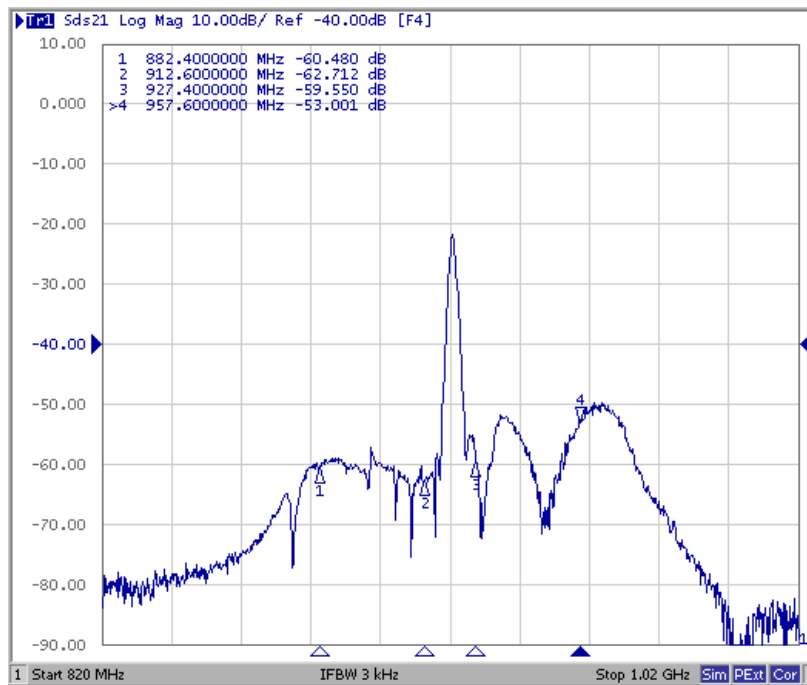

These data **exclude** loss that comes from the test board

# Tx Port

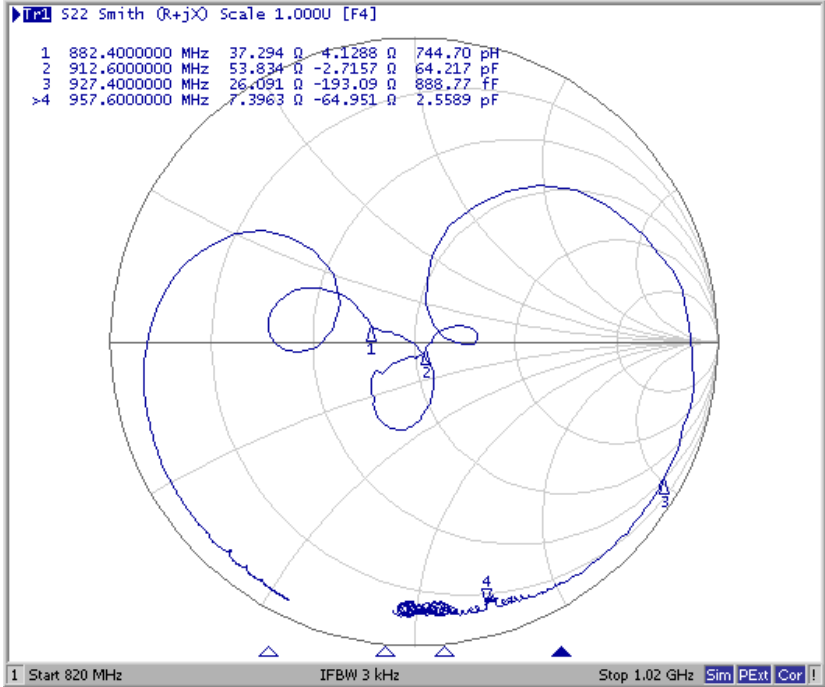
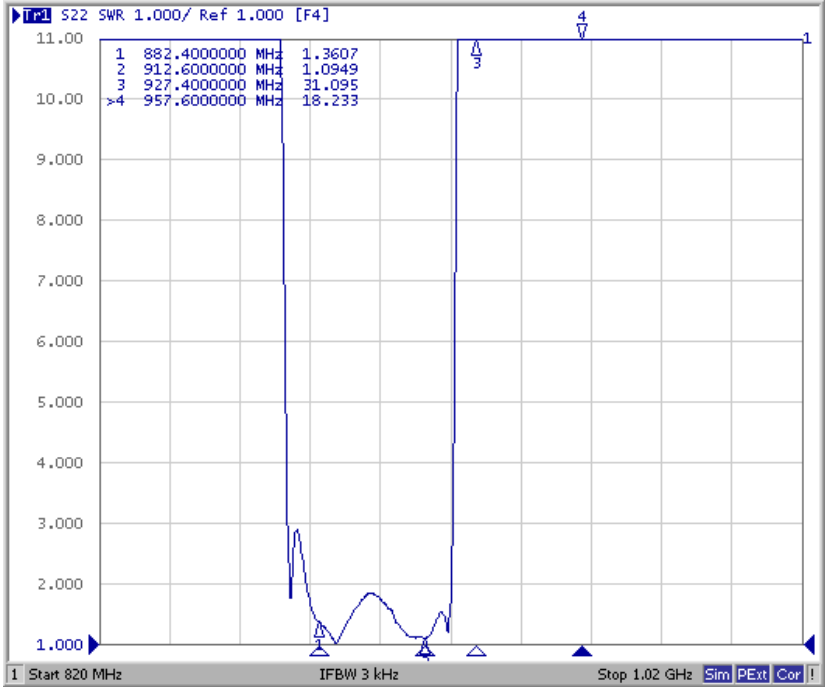

# Rx Port

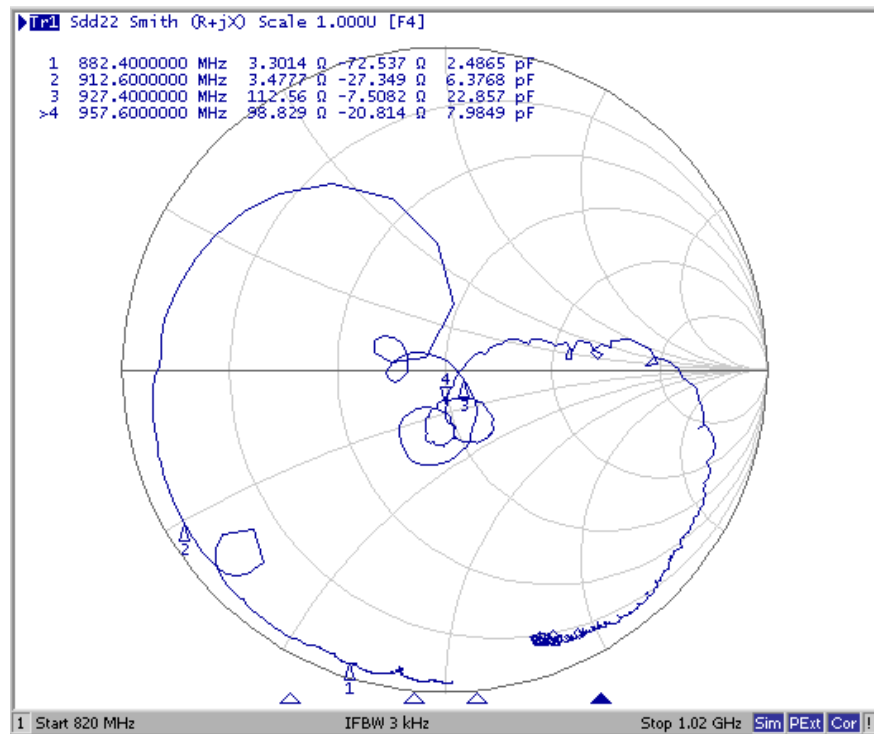
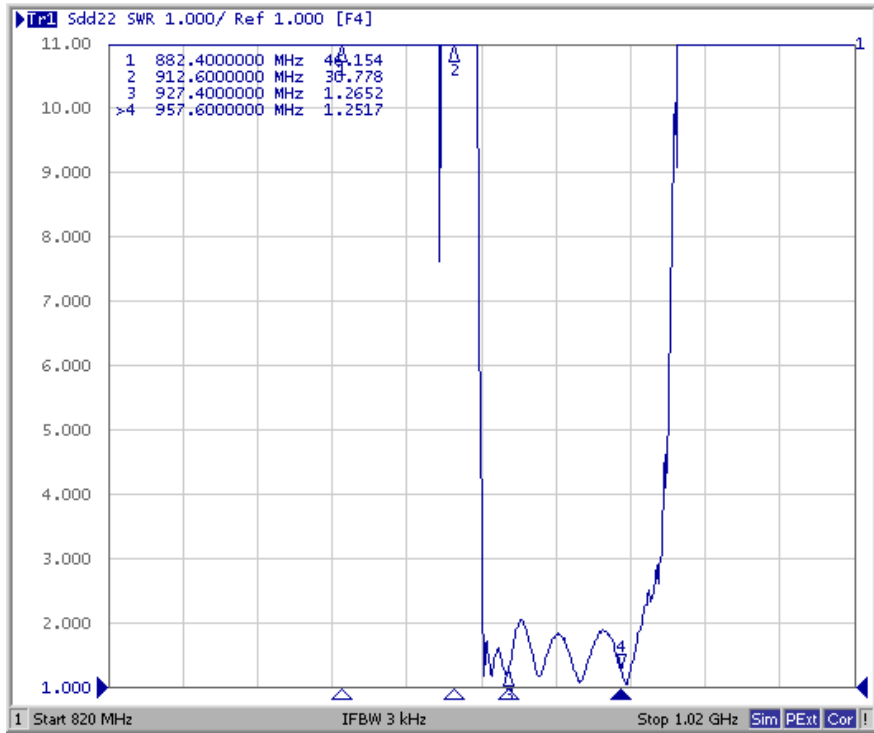

# Ant Port

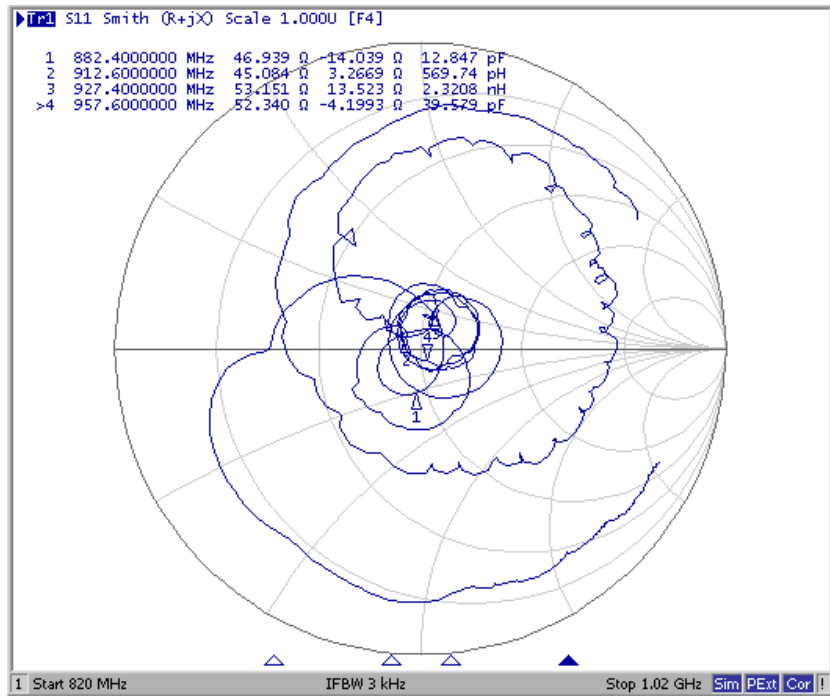
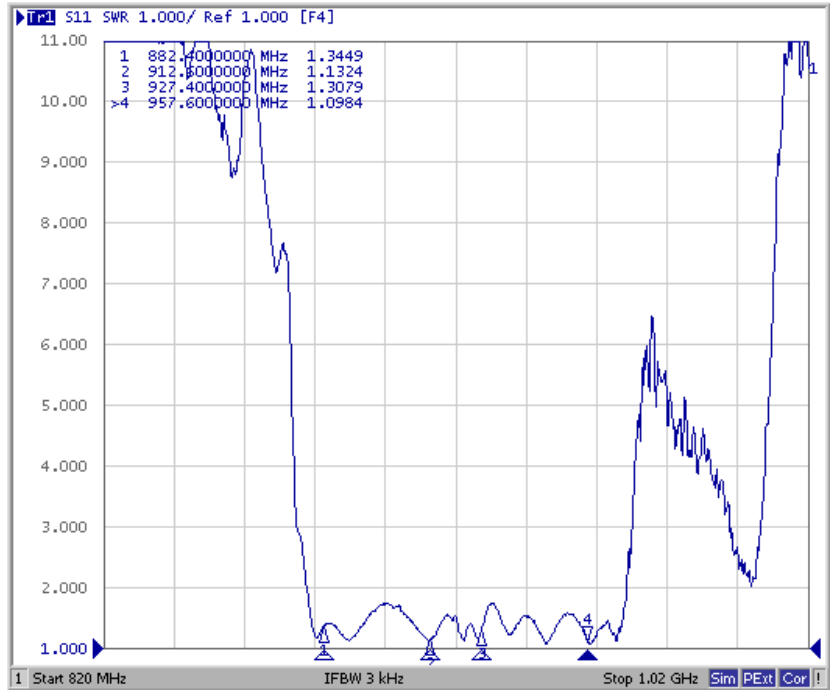



## Ant to Rx (Amplitude balance)

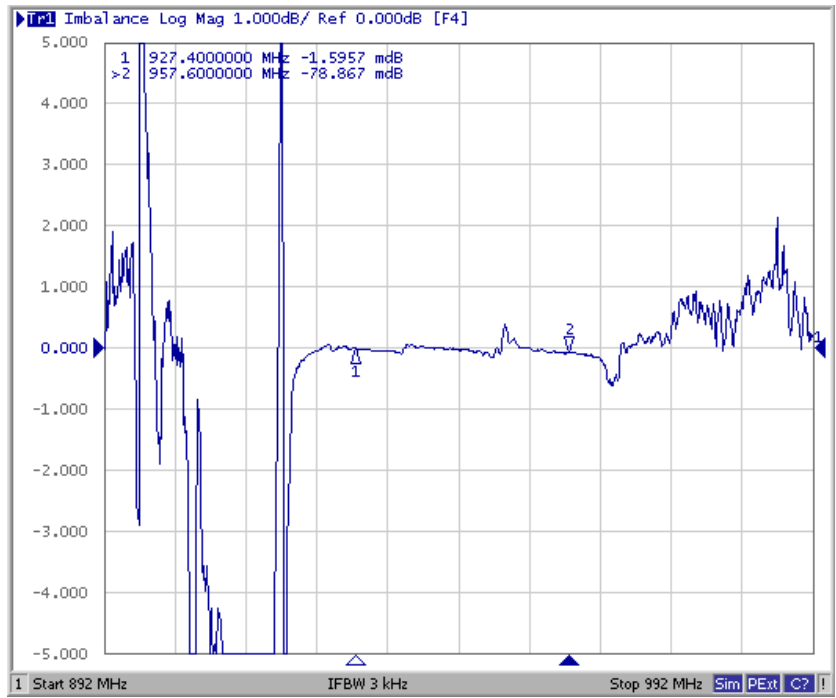

## Ant to Rx (Phase balance)

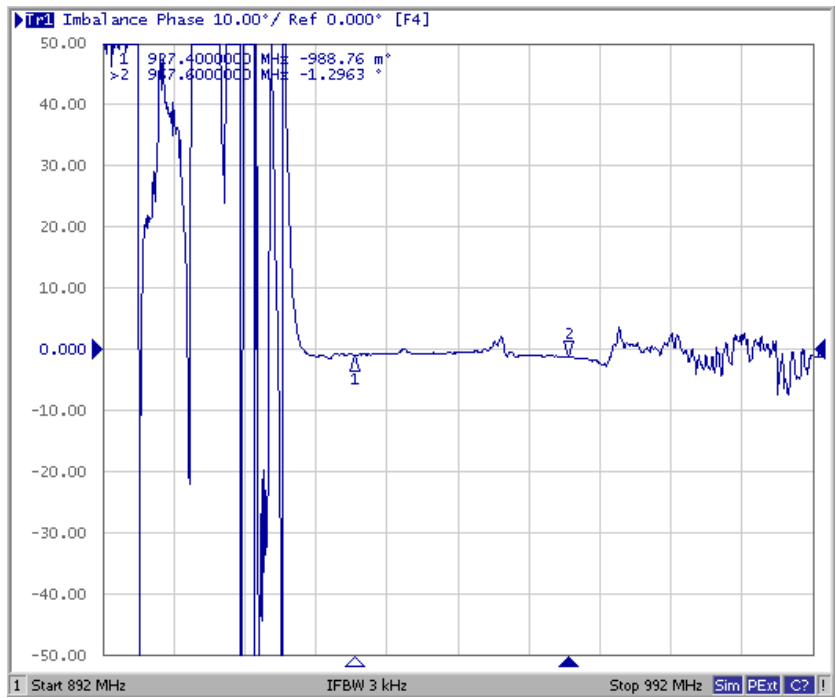

## Tx to Ant (Wide span)

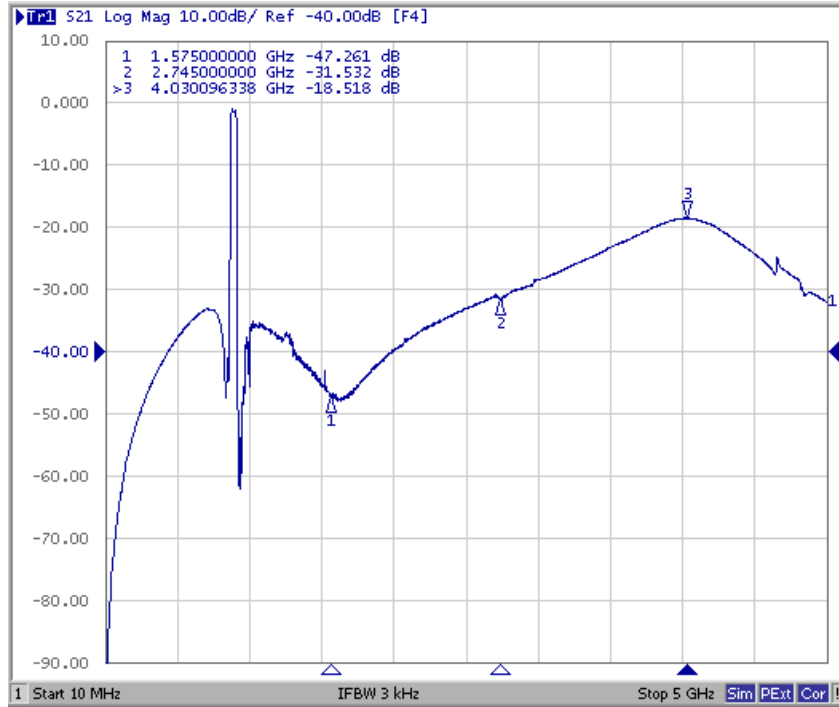

## Ant to Rx (Wide span)

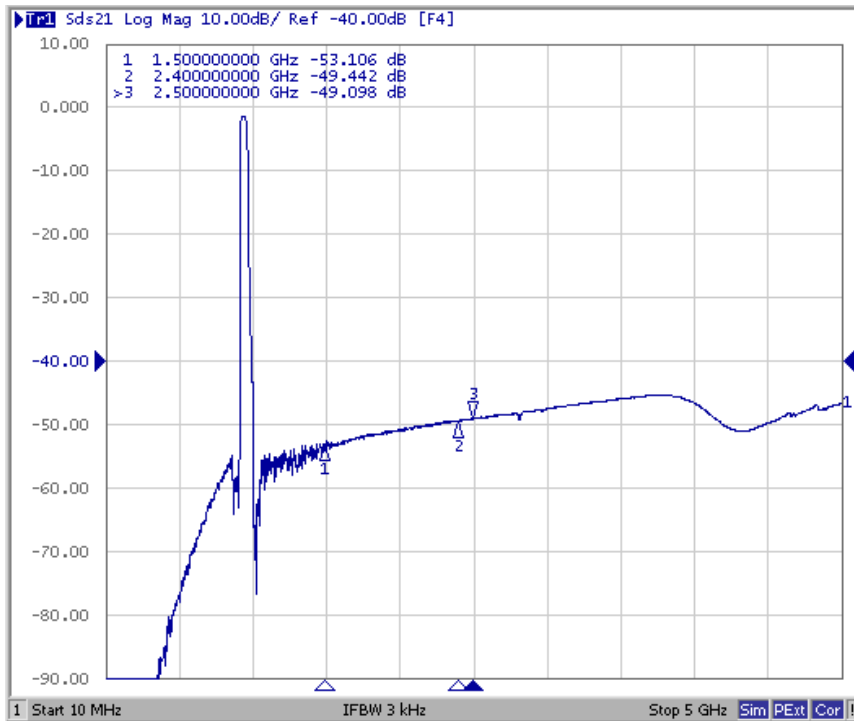

**E.OUTLINE DRAWIN:  
(Mass Production)**

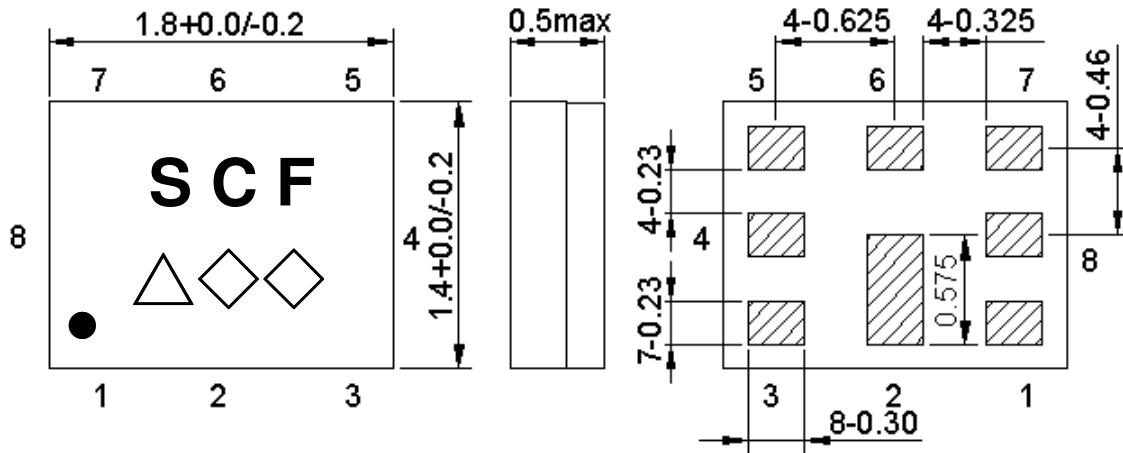

Marking name : SCF

△: Date code( 2016 May → s ,....., 2019 Dec→m.)

◇◇: Lot Code.

Product Date Code. Follow below table.

Year	Jan	Feb	Mar	Apr	May	Jun	Jul	Aug	Sep	Oct	Nov	Dec
2016	n	p	q	r	s	t	u	v	w	x	y	z
2017	A	B	C	D	E	F	G	H	J	K	L	M
2018	N	P	Q	R	S	T	U	V	W	X	Y	Z
2019	a	b	c	d	e	f	g	h	j	k	l	m

**Pin Configuration**

Pin No.	Pin name	Description
1	Rx	Receiver Pin (balanced)
2	GND	Ground Pin
3	Tx	Transmitter Pin
4	GND	Ground Pin
5	GND	Ground Pin
6	ANT	Antenna Pin
7	GND	Ground Pin
8	Rx	Receiver Pin (balanced)

**Figure 1. Dimensions and Pin assignment**

**Top View (Sample Production):**

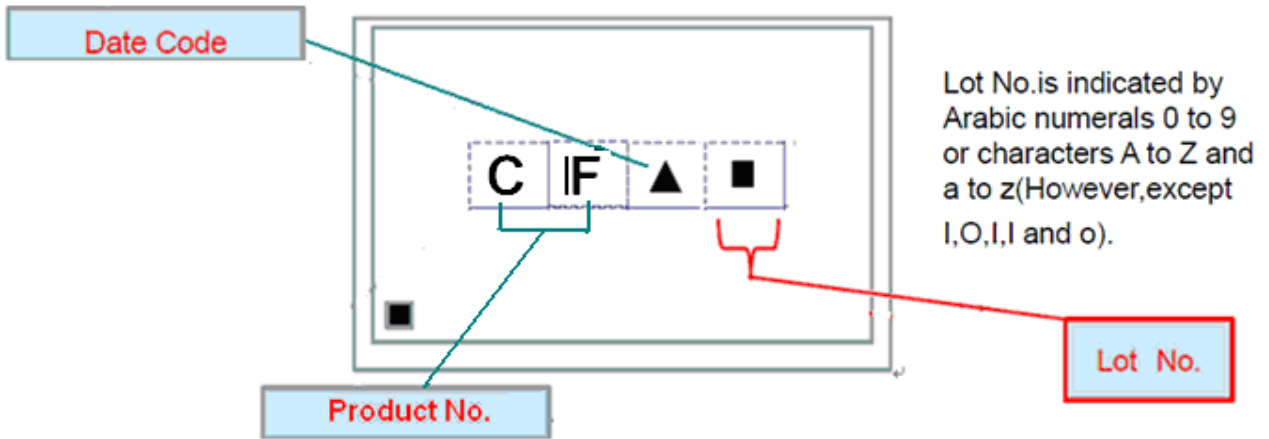

**F. FOOTPRINT:**

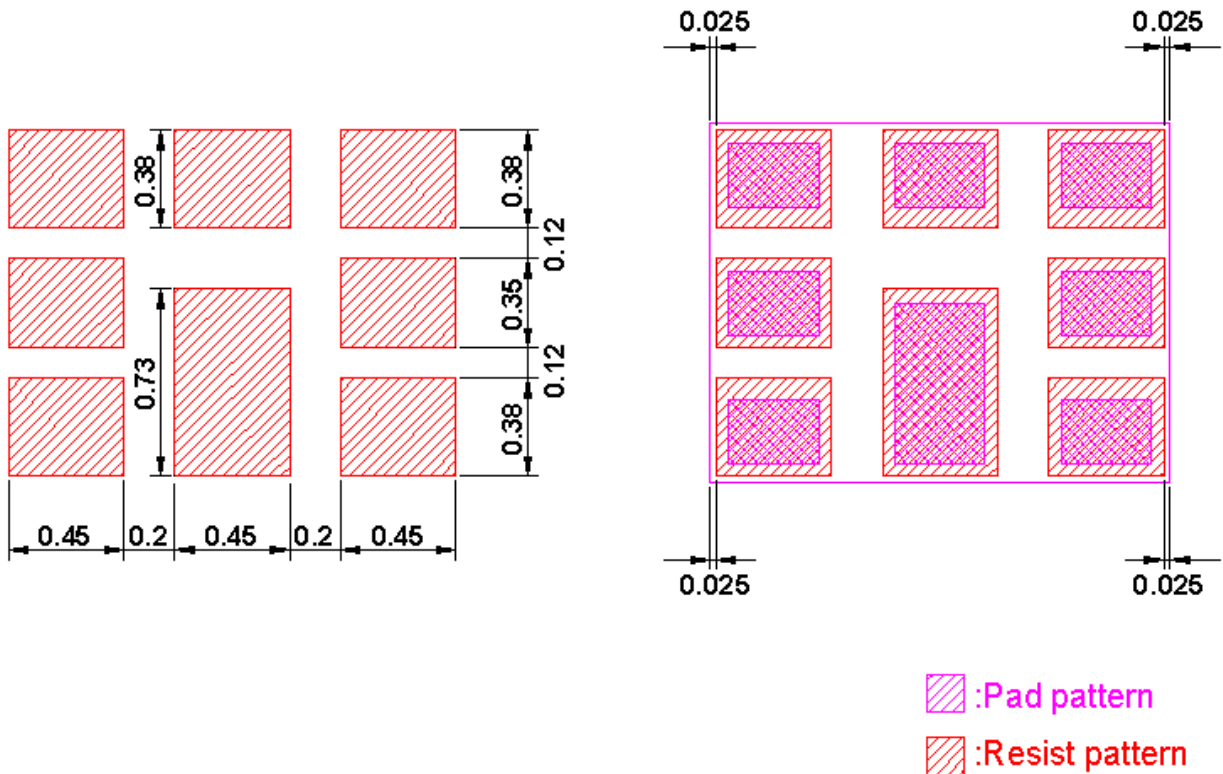

**G. PACKING:**

**1. REEL DIMENSION**

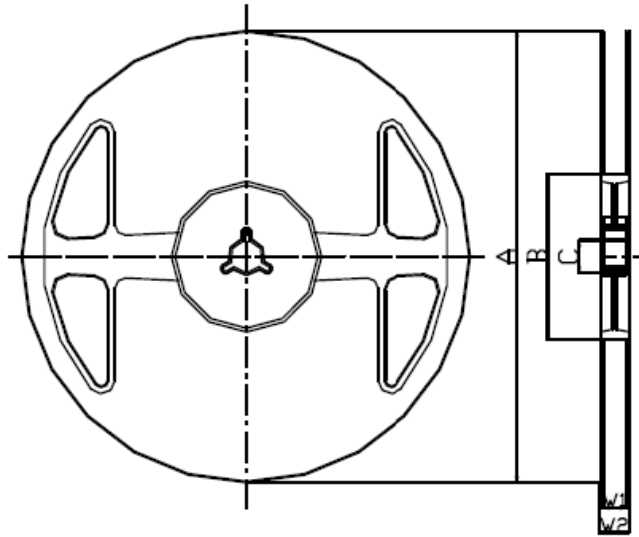

**Materials of Reel**

Material : Polystyrene + Carbon

Characteristics : Conforms to EIAJ-ET-7200A

Color : Black

Surface resistance (reference value) :  $10^9\Omega/\text{sq}$  Max.

Unit : mm

Code	Quantity	A	B	C	W1	W2
Z	3,000 pcs	$\phi 180.0 +0.0/-1.5$	$\phi 66.0 +/-0.5$	$\phi 13.0 +/-0.2$	$9.0 +1.0/-0.0$	$11.4 +/-1.0$

**2. TAPE DIMENSION**

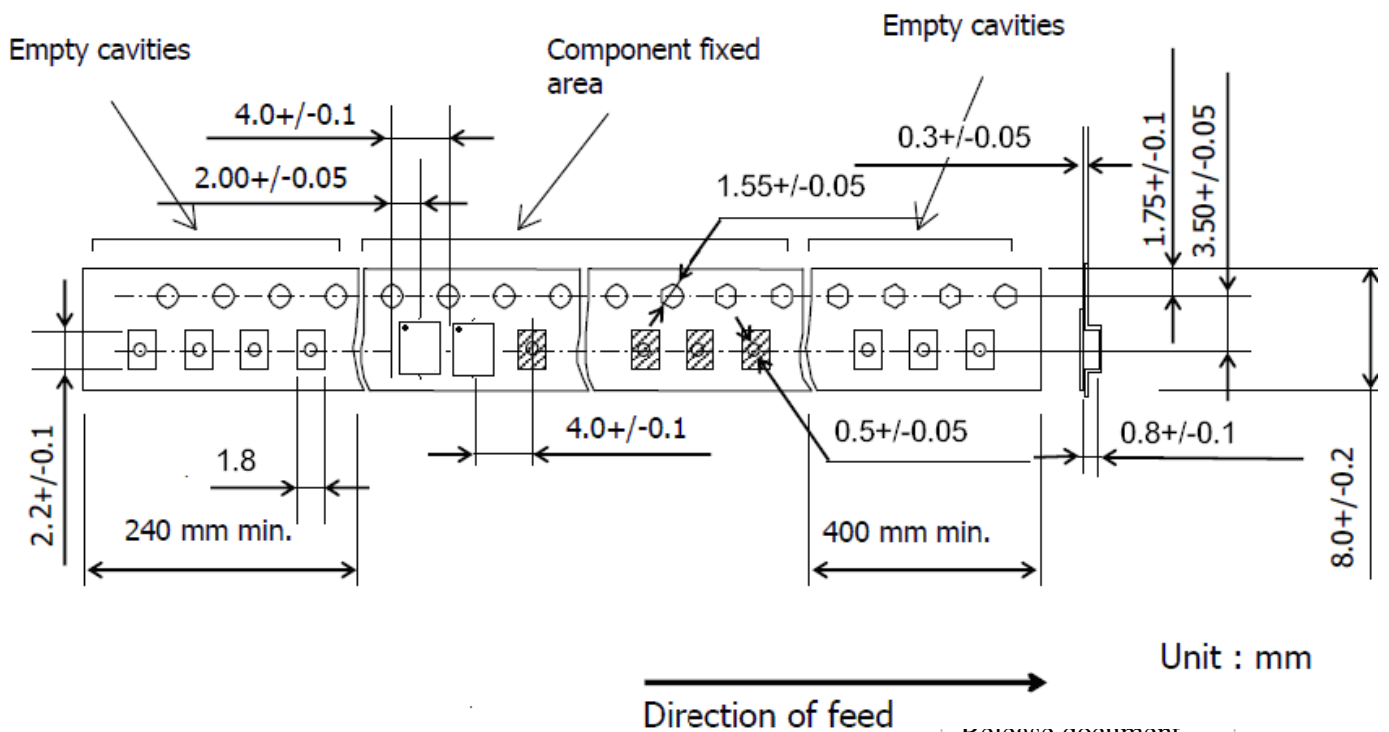

Unit : mm

## H. RECOMMENDED REFLOW PROFILE :

1. Preheating shall be fixed at 150~180°C for 60~90 seconds.
2. Ascending time to preheating temperature 150°C shall be 30 seconds min.
3. Heating shall be fixed at 220°C for 50~80 seconds and at 245~260°C peak (min. 10sec).
4. Time : 2 times.

