



# TAI-SAW TECHNOLOGY CO., LTD.

No. 3, Industrial 2nd Rd., Ping-Chen Industrial District,  
Taoyuan, 324, Taiwan, R.O.C.

## Product Specifications Approval Sheet

Product Description: SAW DPX 897.5 / 942.5 MHz Band 8 SMD 1.8X1.4 mm (BW=35 MHz)

TST Part No.: TF0125D

Customer Part No.: \_\_\_\_\_

Customer signature required
Company: _____
Division: _____
Approved by : _____
Date: _____

Checked by: \_\_\_\_\_ Anne Chen 

Approved by: \_\_\_\_\_ Bob Chau 

Date: \_\_\_\_\_ 04, 10, 2017

1. Customer signed back is required before TST can proceed with sample build and receive orders.
2. Orders received without customer signed back will be regarded as agreement on the specifications.
3. Any specifications changes must be approved upon by both parties and a new revision of specifications shall be released to reflect the change



# TAI-SAW TECHNOLOGY CO., LTD.

No. 3, Industrial 2nd Rd., Ping-Chen Industrial District,  
Taoyuan, 324, Taiwan, R.O.C.

SAW DPX 897.5 / 942.5 MHz Band 8 SMD 1.8X1.4 mm (BW=35 MHz)

MODEL NO.:TF0125D

REV.1.0

## A. MAXIMUM RATING:

1. Operating temperature range: -20 °C to +85 °C
2. Storage temperature range: -40 °C to +85 °C
3. Tx Input power : 29dBm (Ta=+50°C,50000h,CW)
- 3.1Rx Input power : 29dBm (Ta=+50°C, 50000h,CW )
4. Maximum DC Voltage: 0 V
5. Moisture Sensitivity Level: Level 3 (MSL 3)
6. ESD 100V(MM) 200V(HBM)

RoHS Compliant

Lead-free soldering

Electrostatic Sensitive Device (ESD)

## B. ELECTRICAL CHARACTERISTICS:

Terminating impedance (Tx Port): 50 Ω (Single-ended)

Terminating impedance (Rx Port): 50 Ω (Single-ended)

Terminating impedance (Ant Port): 50 Ω (Single-ended)

### Tx to ANT (f<sub>T0</sub>=897.5 MHz)

Parameters Description		Unit	Min	Typ	Max	Remarks
Insertion Loss	880.48 ~ 914.52 MHz	dB	-	2.6	3.6	
	882.4 ~ 912.6 MHz	dB		2.2	2.7	
Amplitude ripple	880 ~ 915 MHz	dBp-p	-	1.6	2.7	
VSWR	ANT		-	1.7	2.2	
	Tx		-	1.7	2.2	

### Attenuation:

10 ~ 716 MHz	dB	30	39	-	
716 ~ 728 MHz	dB	33	41	-	
728 ~ 793 MHz	dB	33	41	-	
832 ~ 862 MHz	dB	28	31	-	
927 ~ 957.6 MHz	dB	42	49		
1559 ~ 1563 MHz	dB	35	39	-	
1565.42 ~ 1573.37 MHz	dB	35	38	-	
1573.37 ~ 1577.47 MHz	dB	35	38	-	
1577.47 ~ 1585.42 MHz	dB	35	38	-	
1597.55 ~ 1605.89 MHz	dB	35	38		
1710 ~ 1785 MHz	dB	30	36		
1760 ~ 1840 MHz	dB	30	35		
1840 ~ 1880 MHz	dB	30	35		
1920 ~ 1980 MHz	dB	30	34		

2110 ~ 2170 MHz	dB	28	32		
2400 ~ 2500 MHz	dB	25	30		
2434 ~ 2494 MHz	dB	25	30		
2620 ~ 2745 MHz	dB	25	30		
3520 ~ 3660 MHz	dB	15	24		
4000 ~ 4575 MHz	dB	5	17		
4900 ~ 5950 MHz	dB	5	17		
6160 ~ 6405 MHz	dB	15	32		
7040 ~ 7320 MHz	dB	15	29		

**ANT to Rx (f<sub>T0</sub>=942.5 MHz)**

Parameters Description		Unit	Min	Typ	Max	Remarks
Insertion Loss	925.48 ~ 959.52 MHz	dB	-	2.5	3.5	
	927.4 ~ 957.6 MHz	dB	-	2.1	2.6	
Amplitude ripple	925 ~ 960 MHz	dB <sub>p-p</sub>		1.6	2.6	
VSWR	ANT	-		1.7	2.2	
	Rx			1.7	2.2	
<b>Attenuation:</b>						
0.3~ 880 MHz		dB	32	37	-	
45 MHz		dB	50	80	-	
835 ~ 870 MHz		dB	33	38		
882.4 ~ 912.6 MHz		dB	45	55		
902.5 ~ 910 MHz		dB	45	62	-	
980 ~ 1045 MHz		dB	35	39	-	
1045 ~ 6000 MHz		dB	17	23		
1427 ~ 1448 MHz		dB	33	39		
1710 ~ 1785 MHz		dB	35	40		
1805 ~ 1980 MHz		dB	35	40		
2400 ~ 2500 MHz		dB	35	41		
2500 ~ 2570 MHz		dB	35	41		
2685 ~ 2790 MHz		dB	35	40		
2775 ~ 2880 MHz		dB	35	39		
2880 ~ 3700 MHz		dB	30	35		
3700 ~ 3840 MHz		dB	27	33		
4625 ~ 4800 MHz		dB	15	23		
4900 ~ 5950 MHz		dB	15	23		
6475 ~ 6720 MHz		dB	10	21		
7400 ~ 7680 MHz		dB	5	15		

**Tx to Rx**

Isolation	882.4 ~ 912.6 MHz	dB	50	54	-	
	927.4 ~ 957.6 MHz	dB	50	53	-	

**Notes :** (1) With Matching Network

### C. FREQUENCY CHARACTERISTICS:

#### Tx to Ant

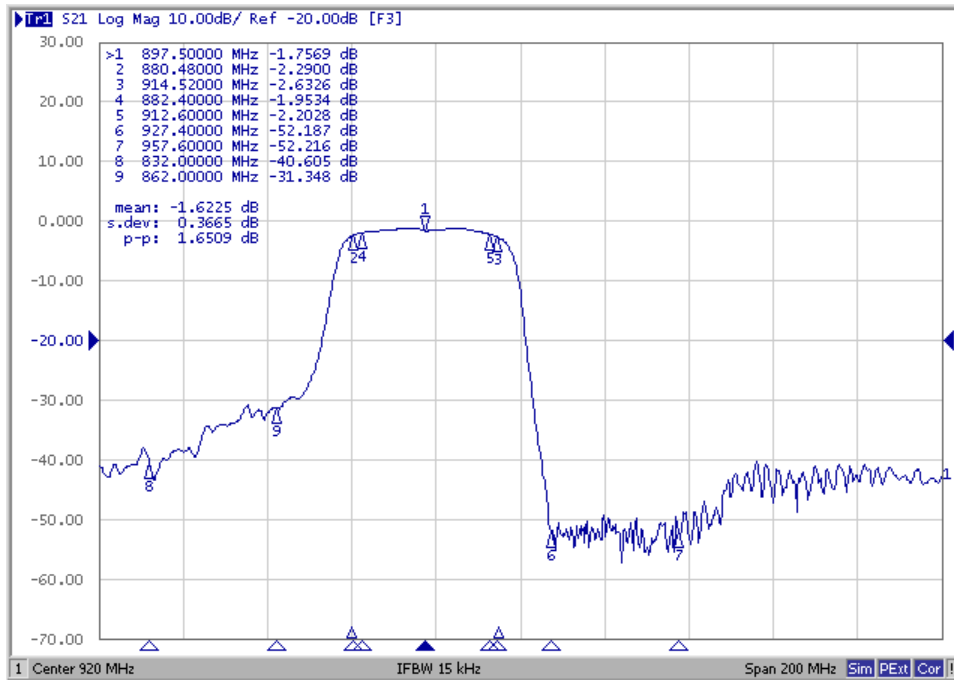

#### Ant to Rx

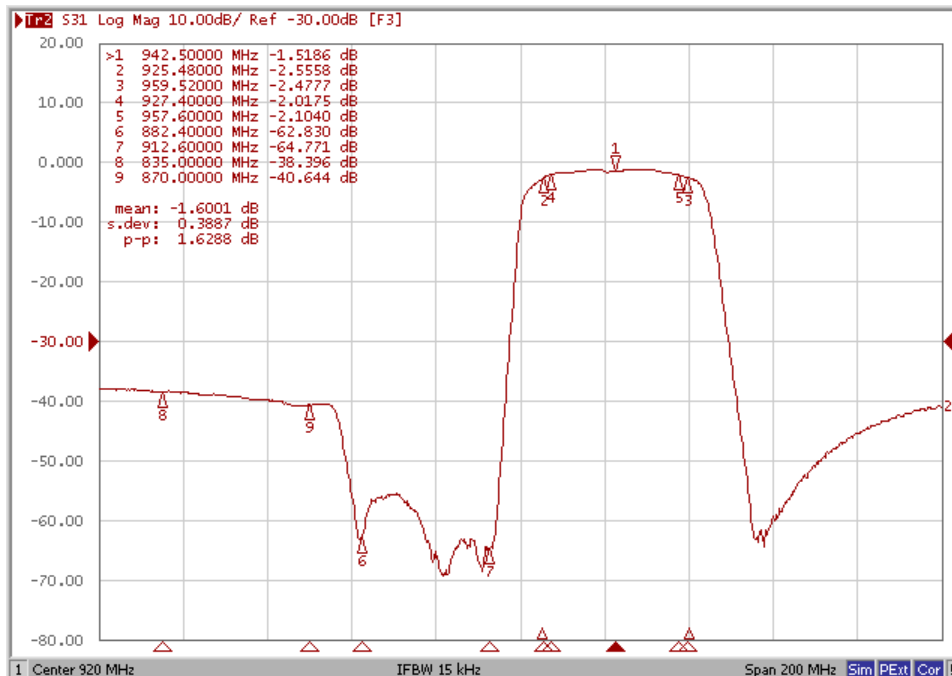

# Ripple Deviation

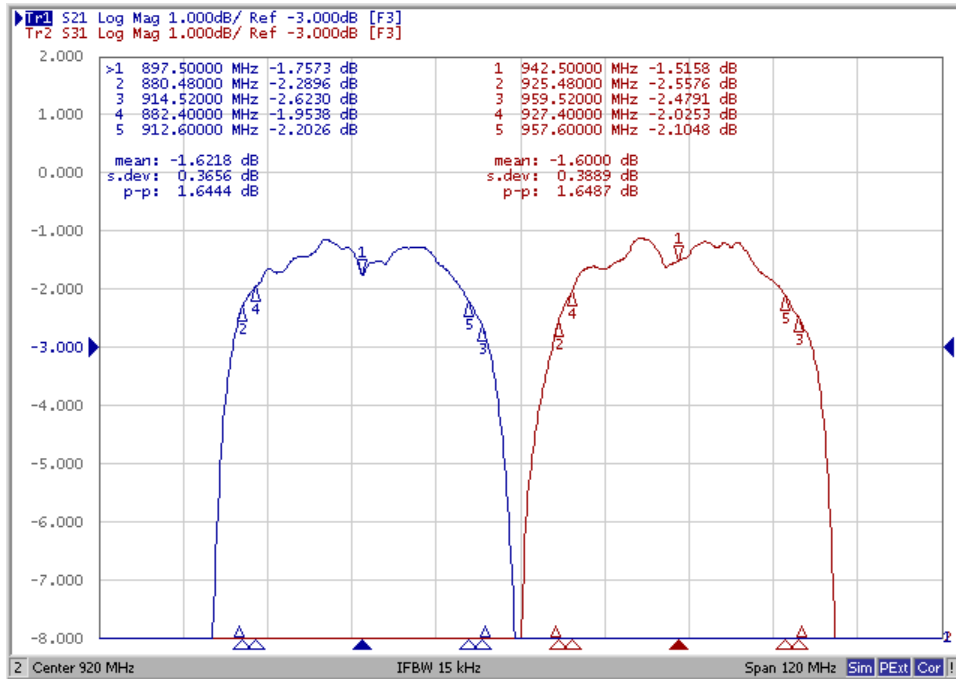

# Isolation

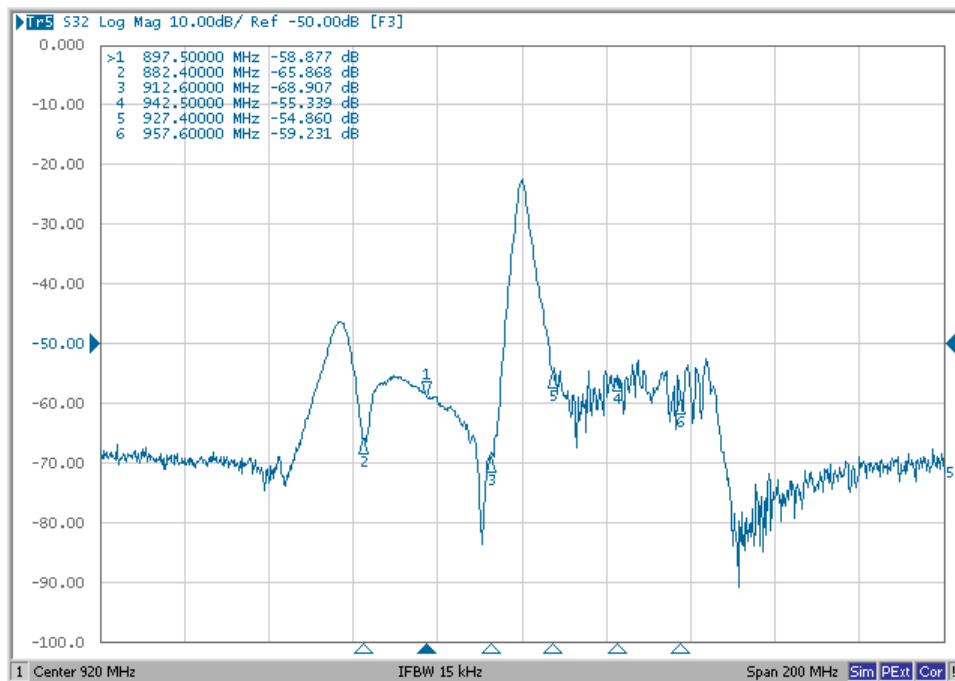

## VSWR (Tx Port)

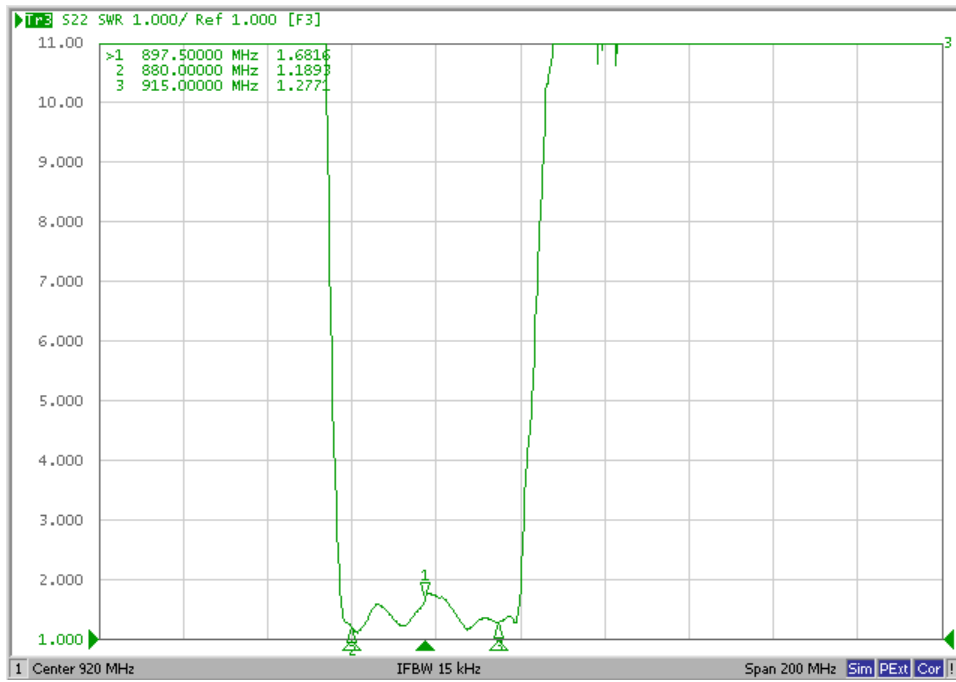

## Smith Chart (Tx Port)

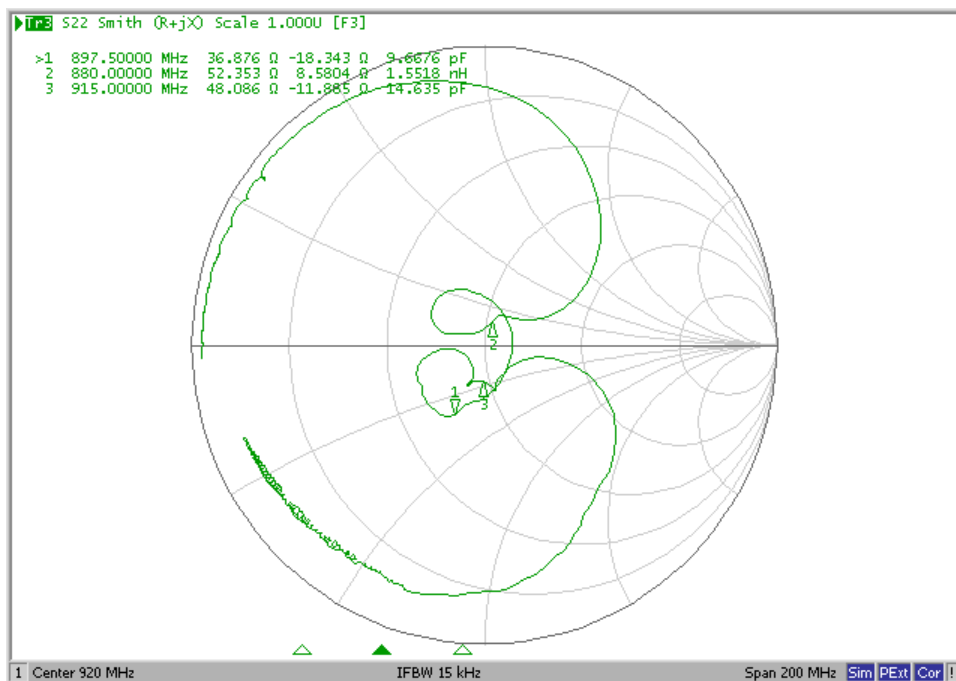

## VSWR (Rx Port)

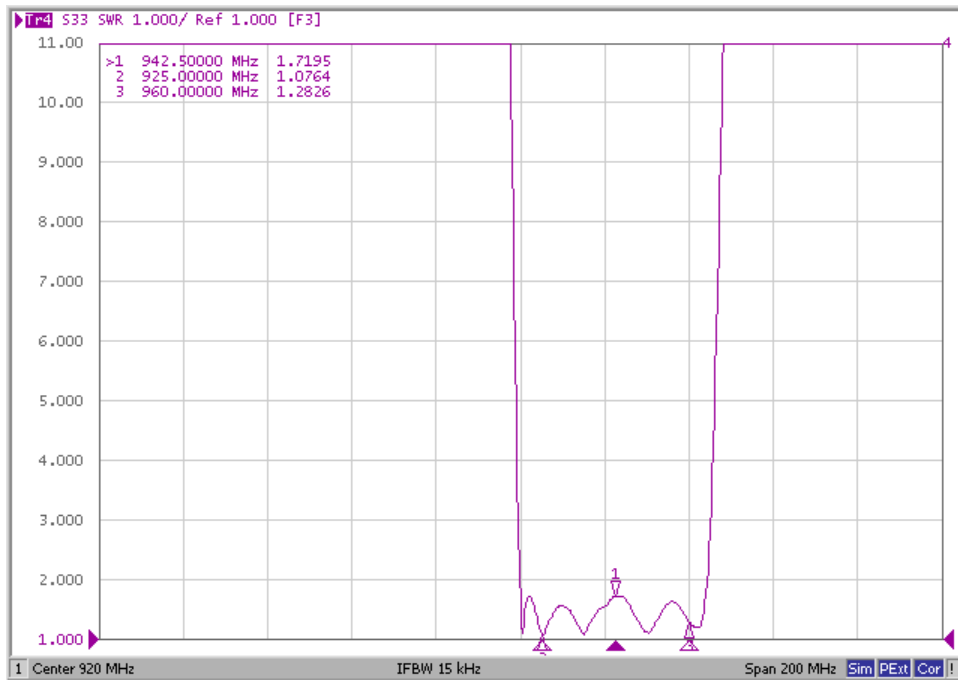

## Smith Chart (Rx Port)

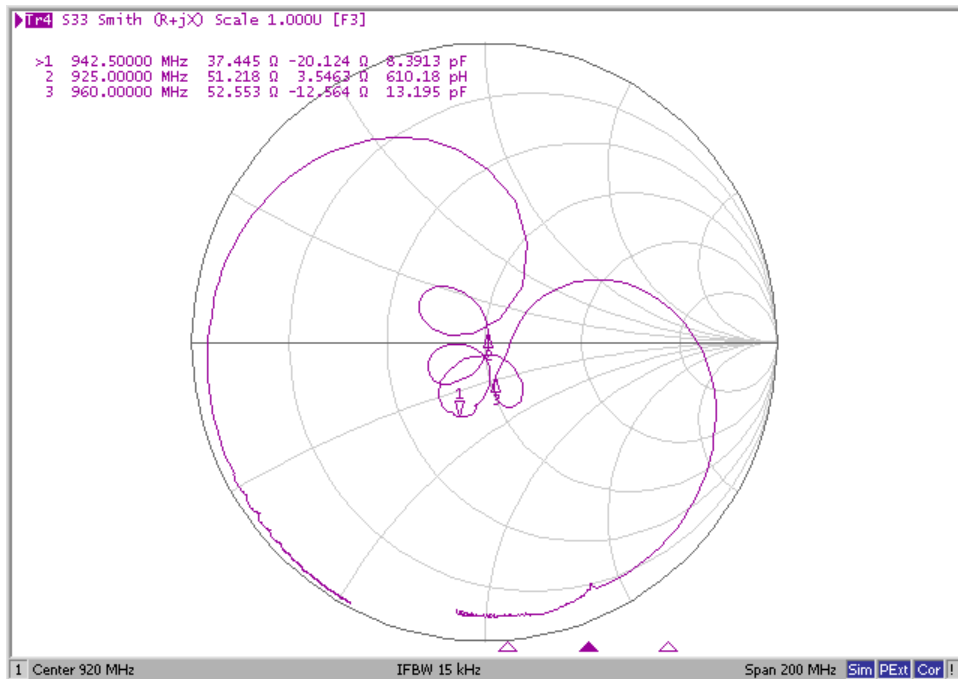

# VSWR (ANT Port)

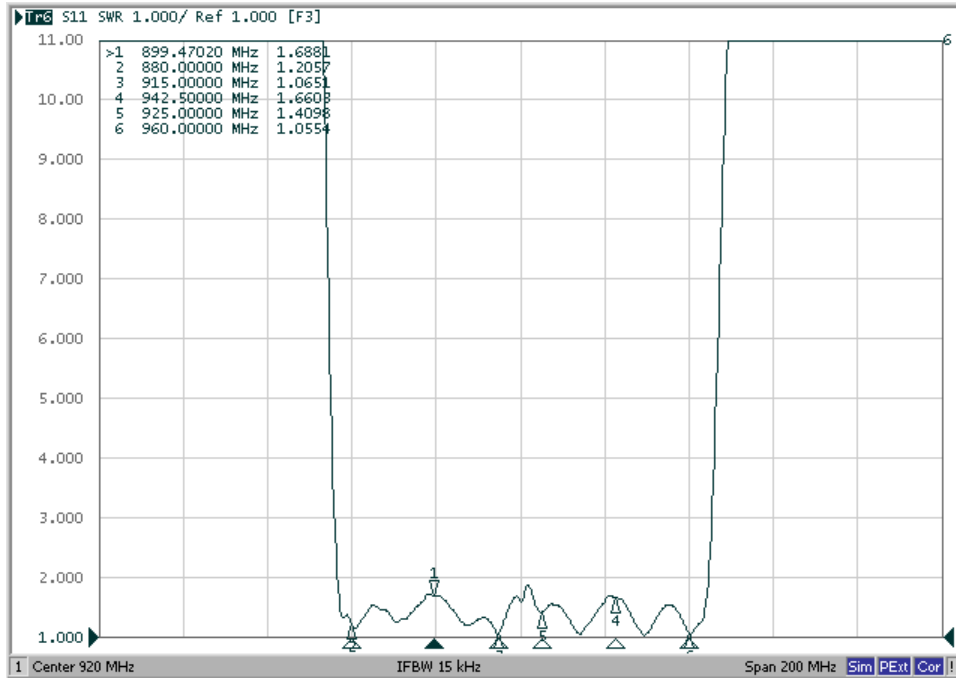

# Smith Chart (ANT Port)

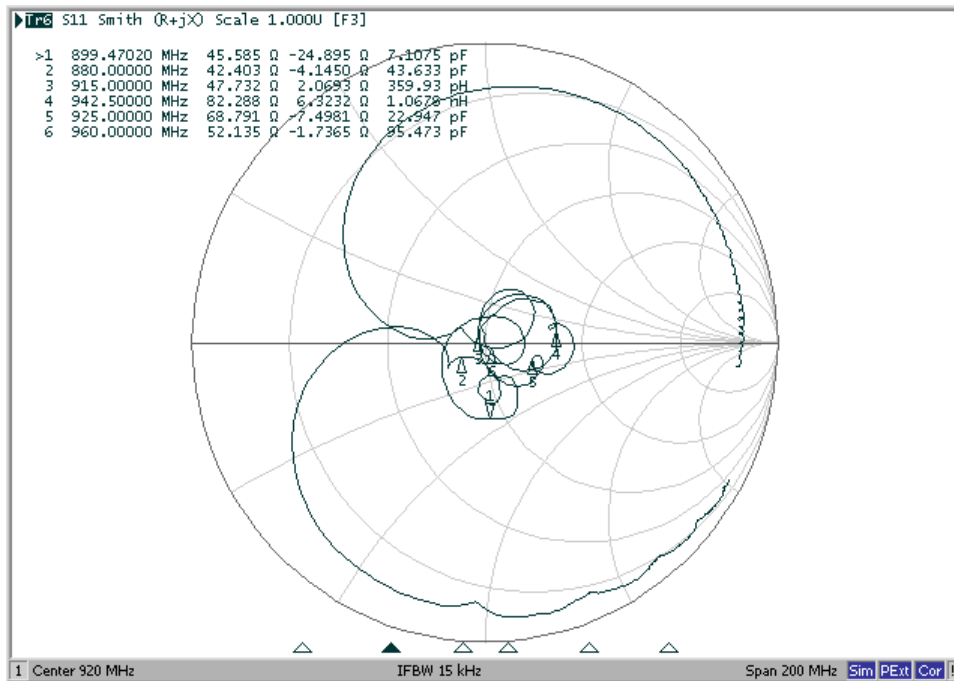



# Wide Span

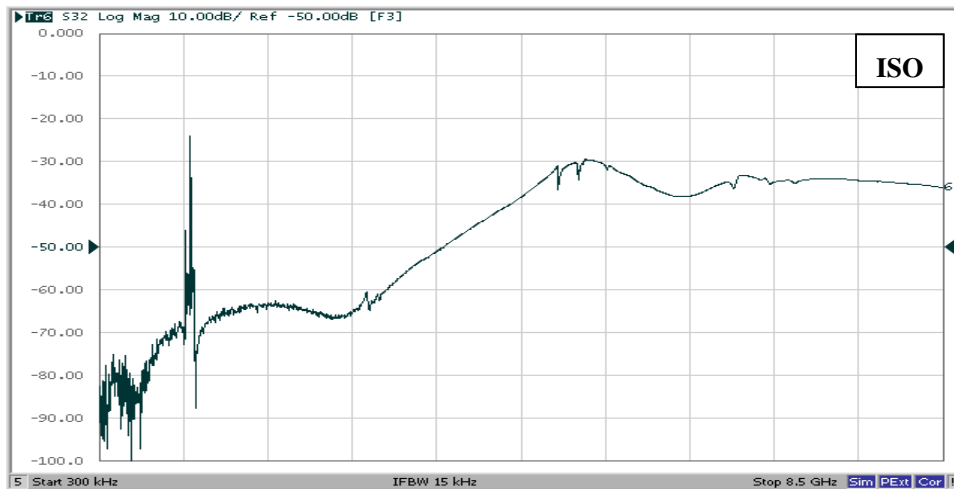
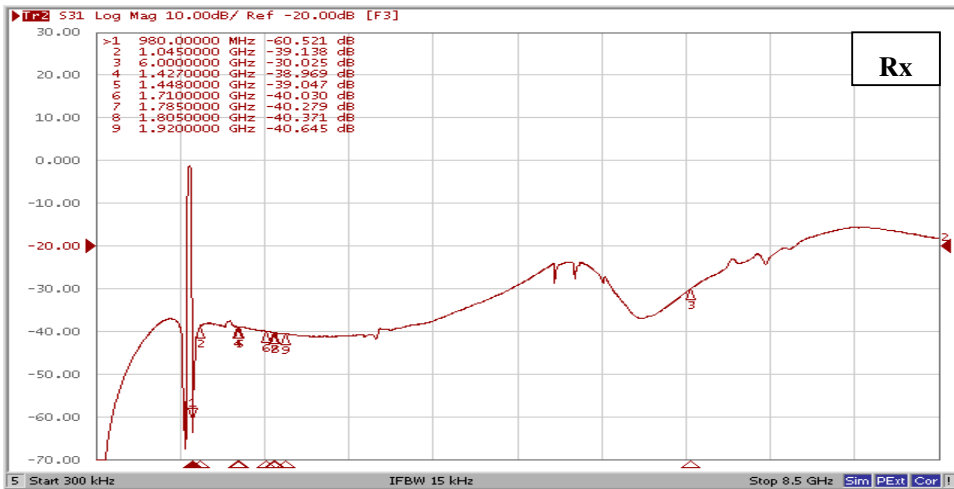
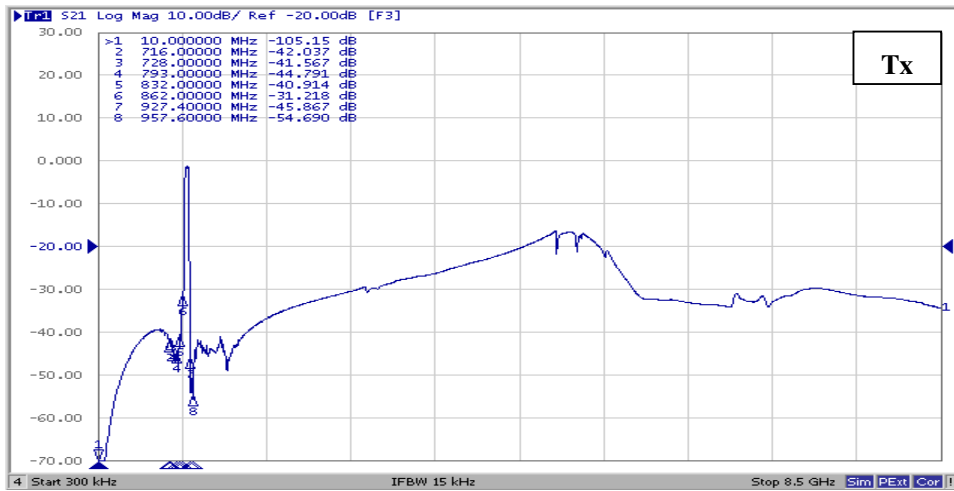

**D.OUTLINE DRAWIN:**

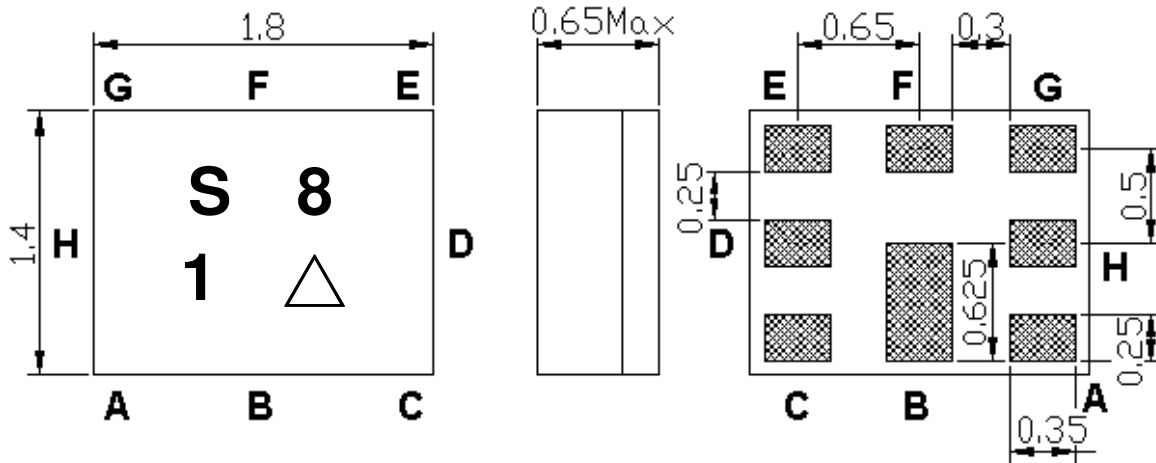

Marking Descriptions	
S	Marking name
8	Band Class
1	Series Number
△	Date Code(Year+Month)

Pin Description	
B,D,E,G,H	Ground
F	Ant
C	Tx (897.5MHz)
A	Rx (942.5MHz)

**Date Code ( year+month)**

Year	Jan.	Feb.	Mar.	Apr.	May.	Jun.	Jul.	Aug.	Sep.	Oct.	Nov.	Dec.
2013	A	B	C	D	E	F	G	H	J	K	L	M
2014	N	P	Q	R	S	T	U	V	W	X	Y	Z
2015	a	b	c	d	e	f	g	h	j	k	l	m
2016	n	p	q	r	s	t	u	v	w	x	y	z
2017	<u>A</u>	<u>B</u>	<u>C</u>	<u>D</u>	<u>E</u>	<u>F</u>	<u>G</u>	<u>H</u>	<u>J</u>	<u>K</u>	<u>L</u>	<u>M</u>
2018	<u>N</u>	<u>P</u>	<u>Q</u>	<u>R</u>	<u>S</u>	<u>T</u>	<u>U</u>	<u>V</u>	<u>W</u>	<u>X</u>	<u>Y</u>	<u>Z</u>
2019	<u>a</u>	<u>b</u>	<u>c</u>	<u>d</u>	<u>e</u>	<u>f</u>	<u>g</u>	<u>h</u>	<u>i</u>	<u>k</u>	<u>l</u>	<u>m</u>
2020	<u>n</u>	<u>p</u>	<u>q</u>	<u>r</u>	<u>s</u>	<u>t</u>	<u>u</u>	<u>v</u>	<u>w</u>	<u>x</u>	<u>y</u>	<u>z</u>

**E. Evaluation Circuit**

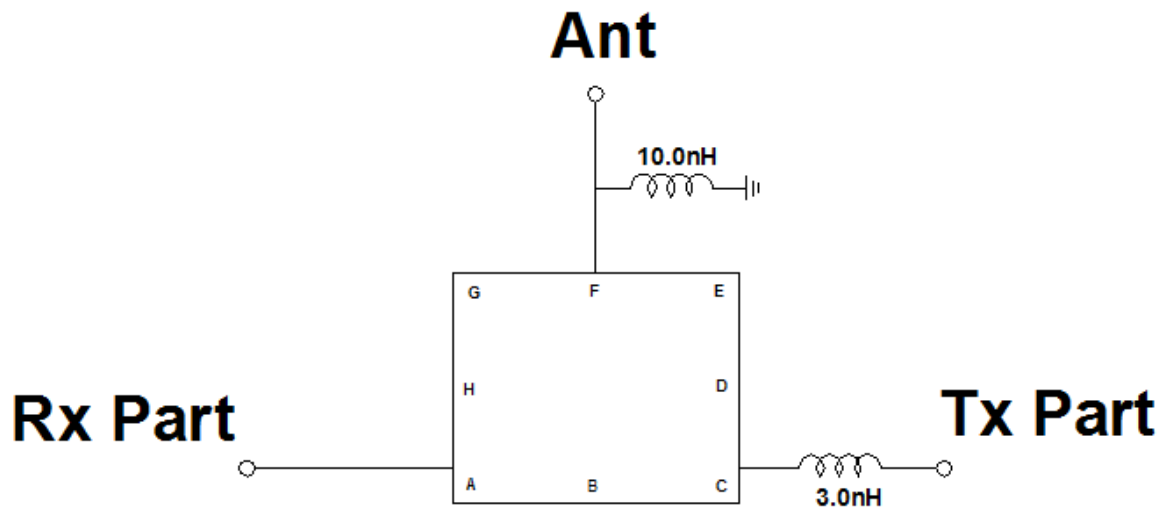

**F. FOOTPRINT:**

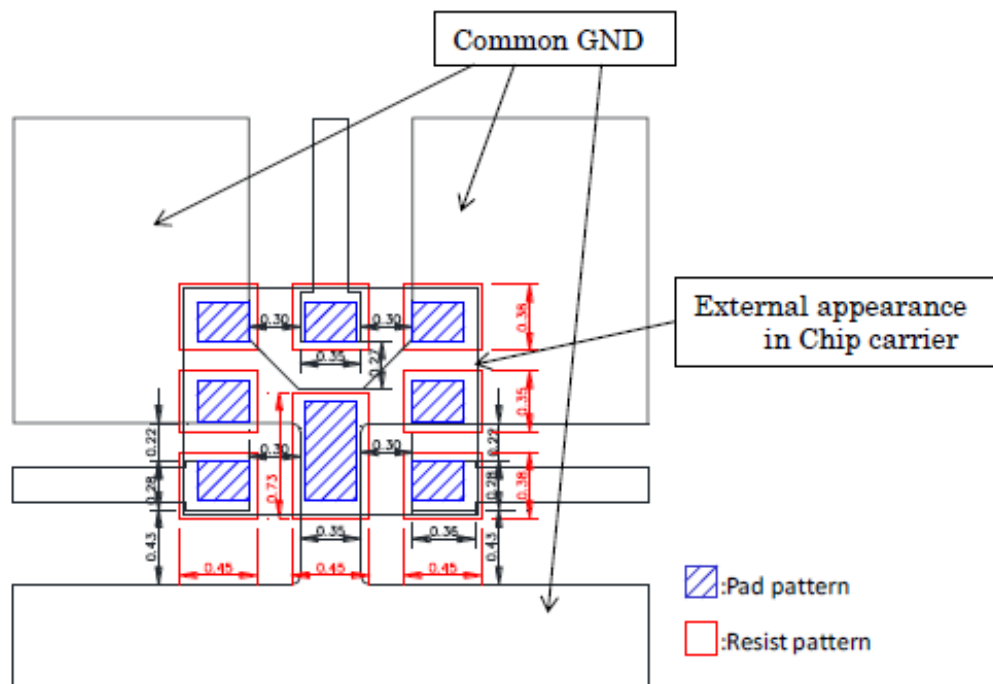

**G. PACKING:**

## 1. REEL DIMENSION

(Please refer to FR-75D10 for packing quantity)

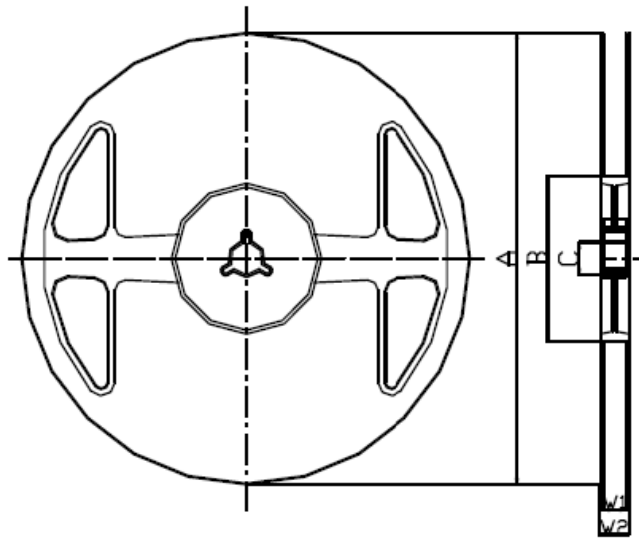

### Materials of Reel

Material : Polystyrene + Carbon

Characteristics : Conforms to EIAJ-ET-7200A

Color : Black

Surface resistance (reference value) :  $10^9\Omega/\text{sq Max.}$

Unit : mm

Code	Quantity	A	B	C	W1	W2
Z	3,000 pcs	$\phi 180.0 +0.0/-1.5$	$\phi 66.0 +/-0.5$	$\phi 13.0 +/-0.2$	$9.0 +1.0/-0.0$	$11.4 +/-1.0$

## 2. TAPE DIMENSION

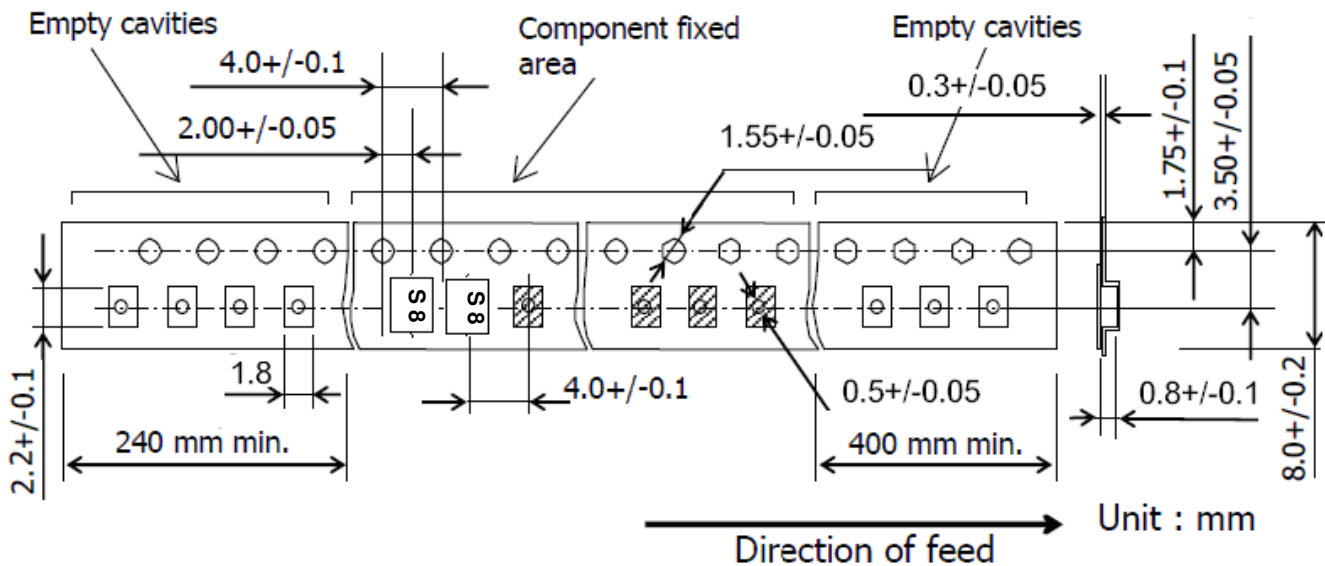

## H. RECOMMENDED REFLOW PROFILE :

1. Preheating shall be fixed at 150~180°C for 60~90 seconds.
2. Ascending time to preheating temperature 150°C shall be 30 seconds min.
3. Heating shall be fixed at 220°C for 50~80 seconds and at 245~260°C peak (min. 10sec).
4. Time : 2 times.

