

Общество с ограниченной ответственностью
«Научно-производственное предприятие «Техно-ПАРК»
(ООО «НПП «Техно-ПАРК»)

Тел/факс (495) 411-96-09

Юридический и фактический адрес: 121357, г. Москва, ул. Верейская, д. 29, стр. 135.

Почтовый адрес для переписки: 121357 Москва, а/я 61.

E-mail: mail@sawtechno.ru

Web: www.sawtechno.ru

Технические характеристики кварцевого резонатора

TZ0532A

Производитель: TAI-SAW TECHNOLOGY CO., LTD

Поставщик: ООО «НПП «Техно-ПАРК» - авторизованный дистрибьютор компании
TAI-SAW TECHNOLOGY CO., LTD

Научно-производственное предприятие ООО «НПП «Техно-ПАРК» разрабатывает и поставляет полосно-пропускающие радиочастотные фильтры на поверхностных акустических волнах (ПАВ) и устройства на их основе. «НПП «Техно-ПАРК» имеет собственную научную и производственную базу, а также является авторизованным дистрибьютором мирового лидера по производству фильтров на ПАВ компании TAI-SAW TECHNOLOGY CO., LTD

E-mail: mail@sawtechno.ru Web: www.sawtechno.ru



TAI-SAW TECHNOLOGY CO., LTD.

No. 3, Industrial 2nd Rd., Ping-Chen Industrial District,
Taoyuan, 324, Taiwan, R.O.C.

Approval Sheet For Product Specification

Issued Date: 2/2/2005 (REV. NO: 1)

Product Name: SMD 5.0x3.2 40MHz Crystal Unit

TST Parts No.: TZ0532A

Customer Parts No. : _____

Company: _____
Division: _____
Approved by: _____
Date: _____

Checked by: _____ Ryan Huang

Approval by: _____ TF Yang

Date: _____ 2/2/2005



TAI-SAW TECHNOLOGY CO., LTD.

No. 3, Industrial 2nd Rd., Ping-Chen Industrial District,
Taoyuan, 324, Taiwan, R.O.C.

SMD 5.0x3.2 40MHz Crystal Unit

MODEL NO.: TZ0532A

REV. NO.: 1

Features:

- Surface Mount Seam Weld Package
- Excellent Reliability Performance
- Good Frequency Perturbation and Stability over temperature

RoHS Compliant
Lead free
Lead-free soldering

Description and Applications:

Surface mount 5.0mmx3.2mm crystal unit for use in wireless telecommunications devices, especially for a need of ultra miniature package for mobility.

Electrical Specifications:

TZ0532A	Specification
Nominal Frequency	40.000000 MHz
Mode of Oscillation	3 rd Overtone
Storage Temperature Range	-40°C to +85°C
Operating Temperature Range	0°C to +75°C
Frequency Stability over Operating Temperature Range	+/-10 ppm (referred to the value at 25°C)
Frequency Make Tolerance (FL)	+/-8 ppm @ 25°C +/- 3°C
Equivalent Series Resistance (ESR)	80 Ω max
Nominal Drive Level	10 uW
Shunt Capacitance (Co)	3 pF max
Load Capacitance (CL)	8.5 pF
Insulation Resistance	500 MΩ min./DC 100V
Marking	Laser Marking

Mechanical Dimensions (mm):

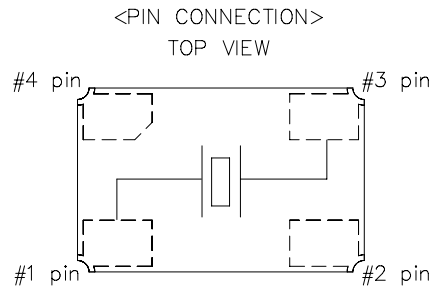
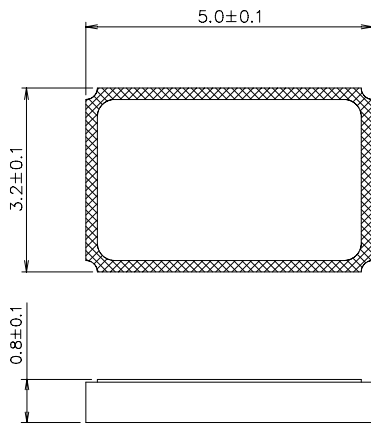

Marking #2, #4 is connected with metal cap of top.

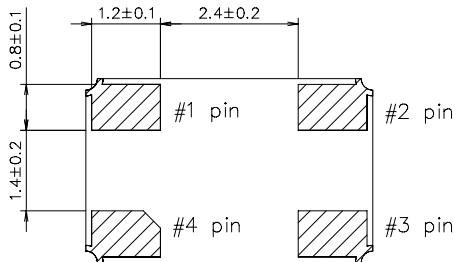

	Pin Connection
#1 pin	IN/OUT
#2 pin	GND
#3 pin	IN/OUT
#4 pin	GND

Marking:

Line 1: Frequency (40.000)

Line 2: TST Logo + Crystal Product Code + Date Code

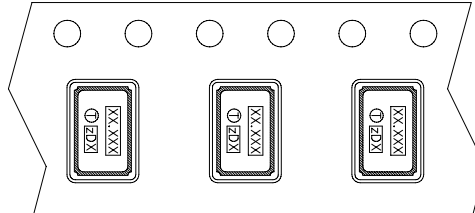
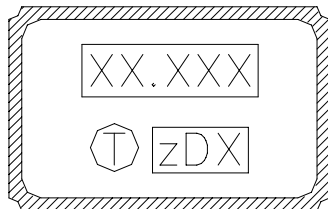

Product Code Table

Year	2001	2002	2003	2004
	2005	2006	2007	2008
Product Code	Z	z	<u>Z</u>	<u>z</u>

Date Code Table

WK01	WK02	WK03	WK04	WK05	WK06	WK07	WK08	WK09	WK10	WK11	WK12	WK13
A	B	C	D	E	F	G	H	I	J	K	L	M
WK14	WK15	WK16	WK17	WK18	WK19	WK20	WK21	WK22	WK23	WK24	WK25	WK26
N	O	P	Q	R	S	T	U	V	W	X	Y	Z
WK27	WK28	WK29	WK30	WK31	WK32	WK33	WK34	WK35	WK36	WK37	WK38	WK39
a	b	c	d	e	f	g	h	i	j	k	l	m
WK40	WK41	WK42	WK43	WK44	WK45	WK46	WK47	WK48	WK49	WK50	WK51	WK52
n	o	p	q	r	s	t	u	v	w	x	y	z

Reel Dimensions (mm):

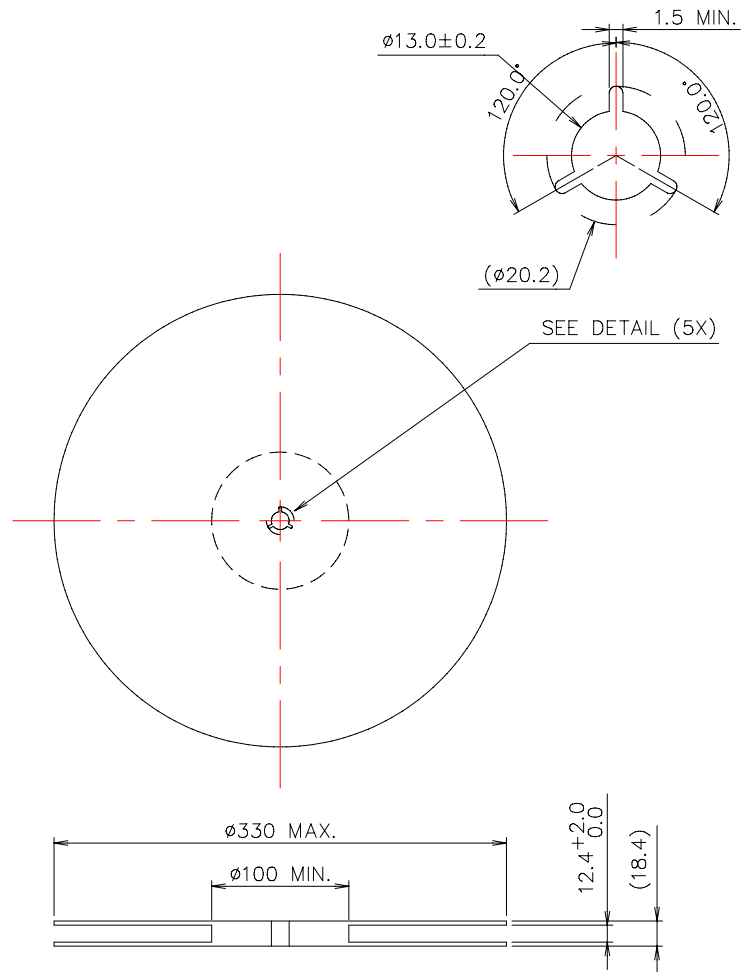

Tape Dimensions (mm):

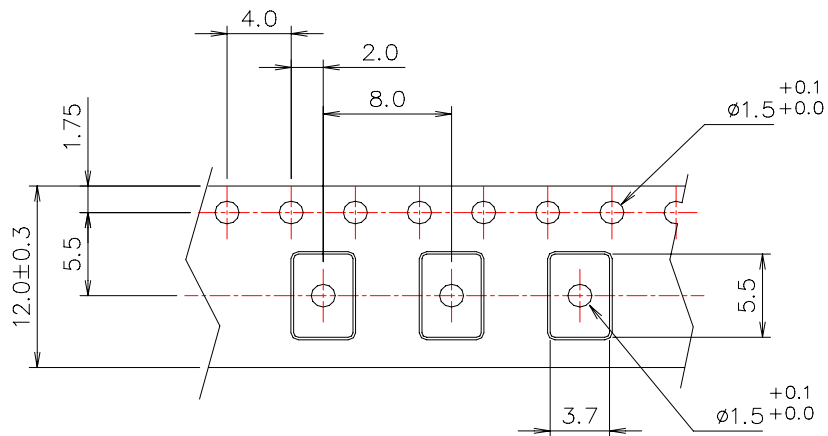

[NOTE]:

1. Unless otherwise specified tolerance on dimension $\pm 0.1 \text{ mm.}$
2. Material: conductive polystyrene with color black.
3. 10 pitch cumulative tolerance $\pm 0.2 \text{ mm.}$

Reflow Profile:

1. Preheating shall be fixed at 140 ~ 160 °C for 60 ~ 90 seconds.
2. Ascending time to preheating temperature 150 °C shall be 30 seconds min.
3. Heating shall be fixed at 200 °C for 50 ~ 60 seconds and at 230 ±10 °C peak.

