



TAI-SAW TECHNOLOGY CO., LTD.

No. 3, Industrial 2nd Rd., Ping-Chen Industrial District,
Taoyuan, 324, Taiwan, R.O.C.

Approval Sheet For Product Specification

Issued Date: 1/19/2005 (REV. NO: 1)

Product Name: SMD 4.0x2.5 18.0MHz Crystal Unit

TST Parts No.: TZ0517A

Customer Parts No : _____

Company: _____
Division: _____
Approved by: _____
Date: _____

Checked by: _____ Ryan Huang

Approval by: _____ TF Yang

Date: _____ 1/19/2005



TAI-SAW TECHNOLOGY CO., LTD.

No. 3, Industrial 2nd Rd., Ping-Chen Industrial District,
Taoyuan, 324, Taiwan, R.O.C.

SMD 4.0x2.5 18.0MHz Crystal Unit

MODEL NO.: TZ0517A

REV. NO.: 1

Features:

- Surface Mount Seam Weld Package
- Excellent Reliability Performance
- Good Frequency Perturbation and Stability over Temperature
- Ultra Miniature Package

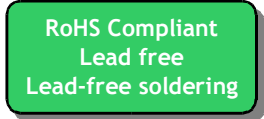

Description and Applications:

Surface mount 4.0mmx2.5mm crystal unit for use in wireless telecommunications devices, especially for a need of ultra miniature package for mobility.

Electrical Specifications:

TZ0517A	Specification
Nominal Frequency	18.000000 MHz
Mode of Oscillation	Fundamental
Storage Temperature Range	-40°C to +85°C
Operating Temperature Range	-10°C to +60°C
Frequency Stability over Operating Temperature Range	+/-10 ppm (referred to the value at 25°C)
Frequency Make Tolerance (FL)	+/-10 ppm @ 25°C +/- 3°C
Equivalent Series Resistance (ESR)	70 Ω max.
Nominal Drive Level	10 uW
Shunt Capacitance (Co)	3 pF max
Load Capacitance (CL)	9 pF
Marking	Laser Marking

Mechanical Dimensions (mm):

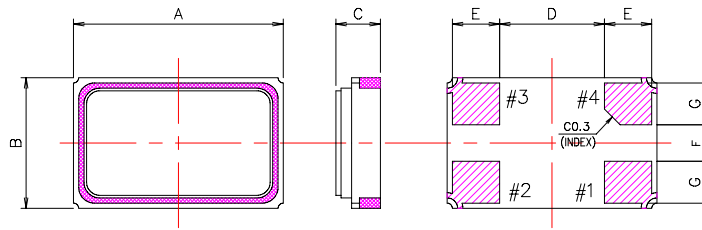

UNIT \ ITEM	A	B	C	D	E	F	G
mm	4.0 ±0.10	2.5 ±0.10	0.80 MAX.	2.0 REF.	0.9 ±0.10	0.7 REF.	0.8 ±0.10

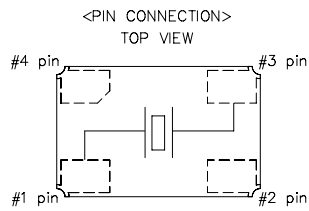

	Pin Connection
#1 pin	IN/OUT
#2 pin	GND
#3 pin	IN/OUT
#4 pin	GND

Marking #2, #4 is connected with metal cap of top.

Recommended Land Pattern (mm):

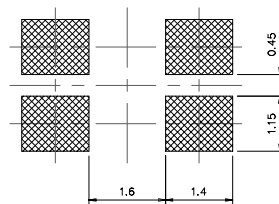

Marking:

Line 1: Frequency (18.00)

Line 2: TST Logo + Crystal Product Code + Date Code

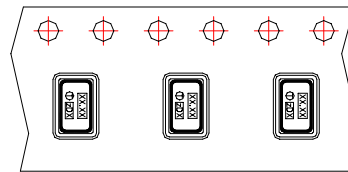
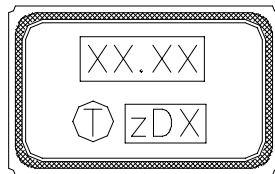

Product Code Table

Year	2001 2005	2002 2006	2003 2007	2004 2008
Product Code	Z	z	⌊	⌋

Date Code Table

WK01	WK02	WK03	WK04	WK05	WK06	WK07	WK08	WK09	WK10	WK11	WK12	WK13
A	B	C	D	E	F	G	H	I	J	K	L	M
WK14	WK15	WK16	WK17	WK18	WK19	WK20	WK21	WK22	WK23	WK24	WK25	WK26
N	O	P	Q	R	S	T	U	V	W	X	Y	Z
WK27	WK28	WK29	WK30	WK31	WK32	WK33	WK34	WK35	WK36	WK37	WK38	WK39
a	b	c	d	e	f	g	h	i	j	k	l	m
WK40	WK41	WK42	WK43	WK44	WK45	WK46	WK47	WK48	WK49	WK50	WK51	WK52
n	o	p	q	r	s	t	u	v	w	x	y	z

Reel Dimensions (mm):

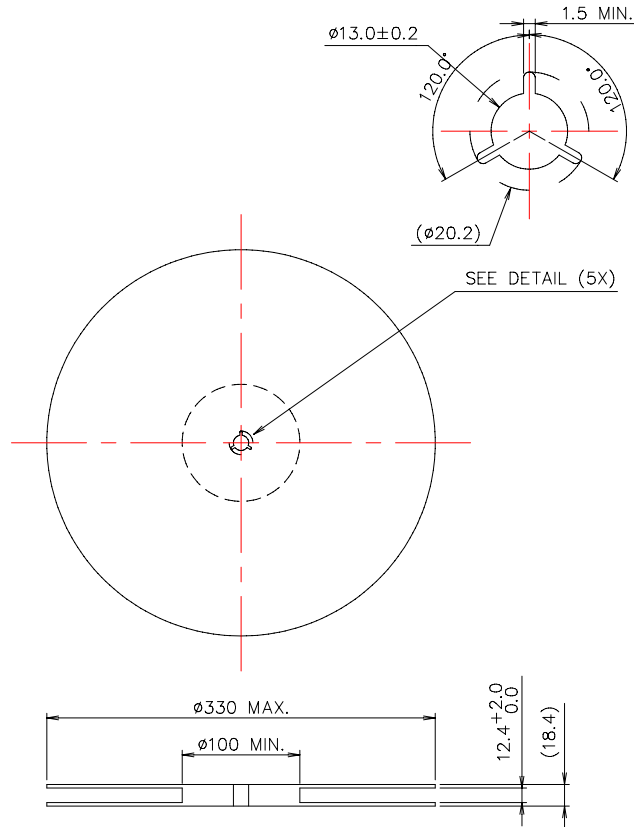

Tape Dimensions (mm):

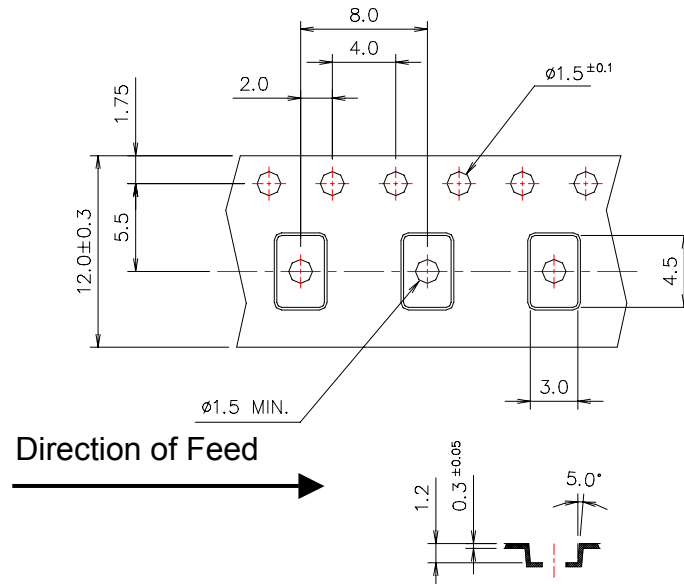

[NOTE]:

1. Unless otherwise specified tolerance on dimension ± 0.1 mm.
2. Material: conductive polystyrene with color black.
3. 10 pitch cumulative tolerance ± 0.2 mm.

Reflow Profile:

1. Preheating shall be fixed at 140 ~ 160 °C for 60 ~ 90 seconds.
2. Ascending time to preheating temperature 150 °C shall be 30 seconds min.
3. Heating shall be fixed at 200 °C for 50 ~ 60 seconds and at 230±10 °C peak.

