

### Applications

- Wireless Infrastructure
- AMPS, CDMA and TDMA
- General Purpose RF Filter
- 4G, Multi-Standard
- UMTS Bands 1 and 10 Downlink
- Repeaters

### Product Features

- 60 MHz Bandwidth
- High Attenuation
- Single-ended Operation
- 50 Ohm Impedance
- Small Size: 3.00 x 3.00 x 1.22 mm
- Ceramic Surface Mount Package (SMP)
- Hermetically Sealed
- RoHS Compliant, Pb-Free 

### General Description

The 856738 is a Surface Acoustic Wave (SAW) based filter suitable for UMTS band 1 and 10 downlink.

856738 is specifically designed to meet the high performance expectations of insertion loss and rejection for UMTS downlink systems under all operating conditions.

This filter is housed in a compact, industry standard 3x3 mm footprint.

Low insertion loss, coupled with high attenuation makes this filter an ideal choice for Base Station Applications.

This filter is part of TriQuint's wide portfolio of RF filters.

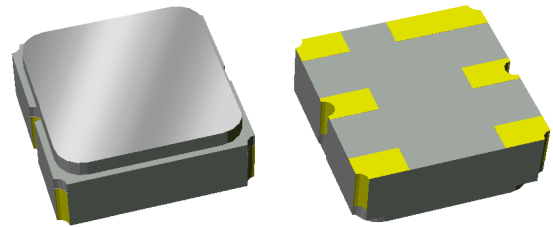

SMP-12, 3.00 x 3.00 x 1.22 mm

### Functional Block Diagram

Top View

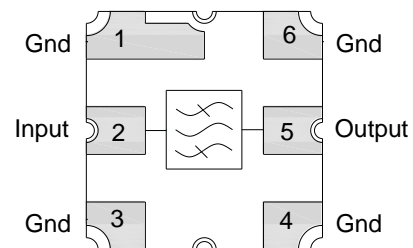

### Pin Configuration - Single Ended

Pin No.	Label
2	Input
5	Output
1,3,4,6	Ground

### Ordering Information

Part No.	Description
856738	2140 MHz SAW Filter
856738-EVB	Evaluation board

Standard T/R size = 5000 units/reel

### Absolute Maximum Ratings

Parameter	Rating
Storage Temperature	-40 to +85 °C
DC Voltage (instantaneous only on any port)	+5 V
Input Power <sup>(1)</sup>	+10 dBm

Notes:

1. Operation of this device outside the parameter ranges given may cause permanent damage.

### Electrical Specifications <sup>(1,2,3)</sup>

Test conditions unless otherwise noted: <sup>(2)</sup> Temp= -30 °C to +85 °C

Parameter <sup>(3)</sup>	Conditions	Min	Typ <sup>(4)</sup>	Max	Units
Center Frequency		-	2140	-	MHz
Insertion Loss	2110 – 2170 MHz	-	2.3	3.5	dB
Amplitude Variation	2110 – 2170 MHz		0.9	1.5	dB p-p
Absolute Attenuation (relative to zero dB)	10 – 1980 MHz	25	27	-	dB
	1980 – 2025 MHz	30	33	-	
	2025 – 2050 MHz	25	31	-	
	2225 – 2260 MHz	30	36	-	
	2260 – 3000 MHz	25	30	-	
Input/Output Return Loss	2110 – 2170 MHz	8	12	-	dB-
Source Impedance <sup>(5)</sup>	single-ended	-	50	-	Ohms
Load Impedance <sup>(5)</sup>	single-ended	-	50	-	Ohms

Notes:

1. All specifications are based on the test circuit shown below.
2. Production test is performed at room temp. to a guard-banded specification to ensure electrical compliance over temperature.
3. Electrical margin has been built into the design to account for variation due to temperature drift and manufacturing tolerances.
4. Typical values are based on average measurements at room temperature
5. This is the optimum impedance in order to achieve the performance shown.

**Evaluation Board                      Matching Schematics**

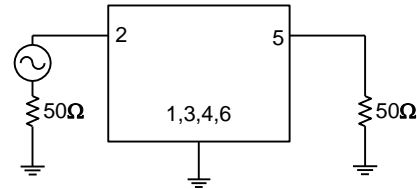
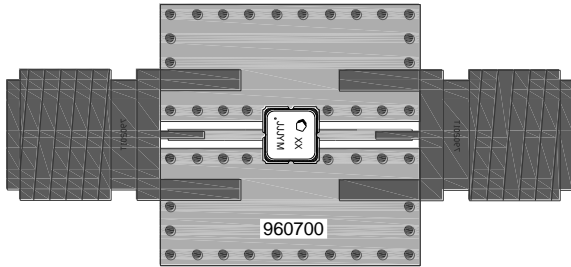

**Notes:**

1. No impedance matching required.
2. PCB: Top, middle & bottom layers: 1 oz copper, Substrates:FR4 dielectric, 031” thick Finish plating: Nickel: 3-8µm thick, Gold: .03-.2µm thick Hole plating: Copper min .0008µm thick

**Bill of Material – 856738-EVB**

Reference Des.	Value	Description	Manuf.	Part Number
DUT	-	2140 MHz SAW filter	TriQuint	856738
SMA	-	SMA connector	Radiall USA Inc.	9602-1111-018
PCB	-	3-Layer	Multiple	960700

**PCB Mounting Pattern**

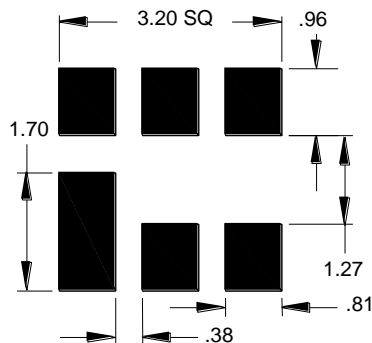

**Notes:**

1. All dimensions are in millimeters. Angles are in degrees.
2. This drawing specifies the mounting pattern used on the TriQuint evaluation board for this product. Some modification may be necessary to suit end user assembly materials and processes.

**Performance Plots**

Test conditions unless otherwise noted: Temp= +25°C

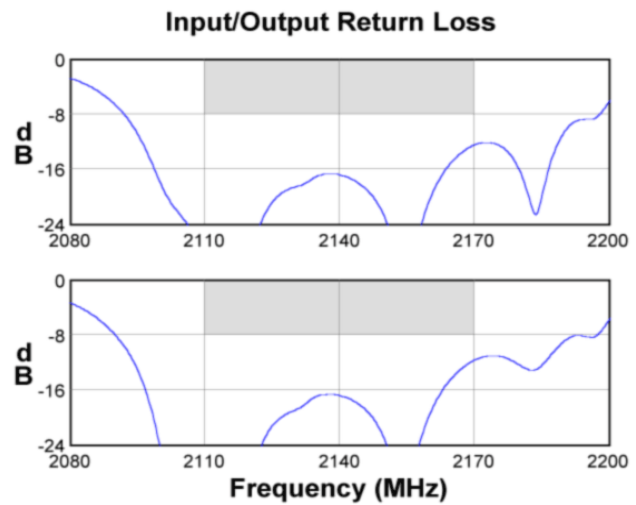
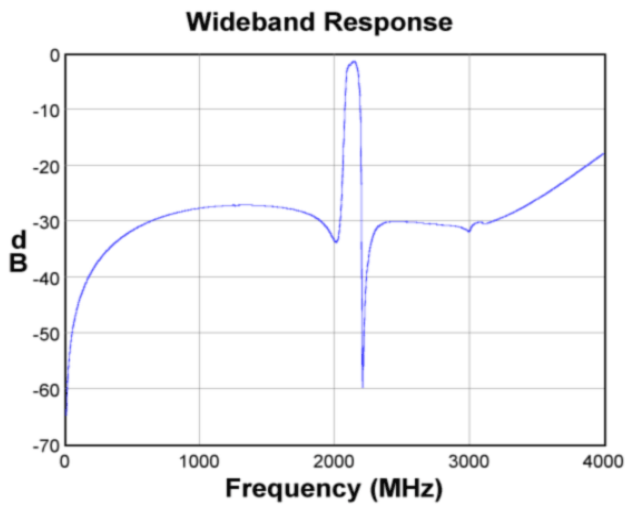
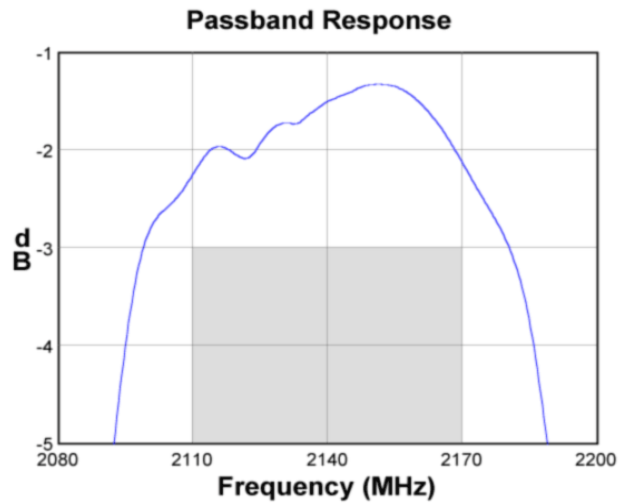
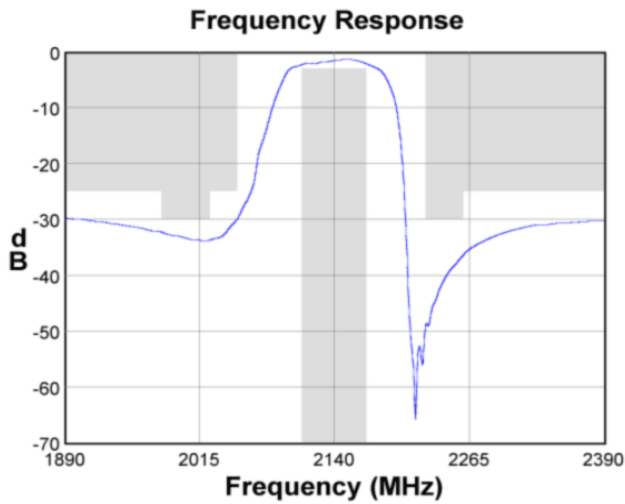

**Input Smith Chart**

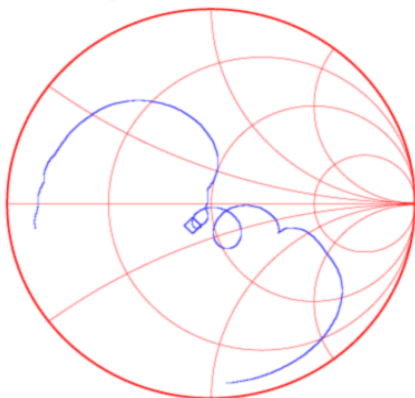

**Output Smith Chart**

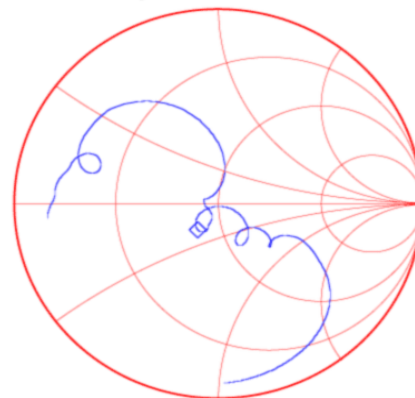

**Package Information, Marking and Dimensions**

Package Style: SMP-12A

Body:  $Al_2O_3$  ceramic  
Lid: Kovar, Ni plated  
Terminations: Au plating 0.5 - 1.0 $\mu$ m, over a 2-6 $\mu$ m Ni plating

The date code consists of JJJ = Julian day, Y = last digit of the year, and M = manufacturing site code

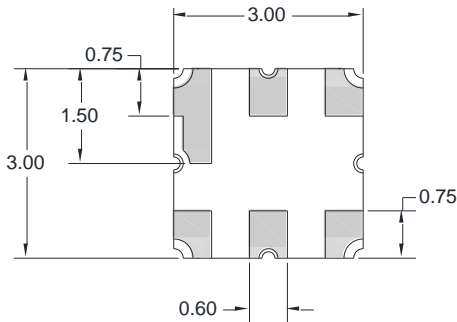
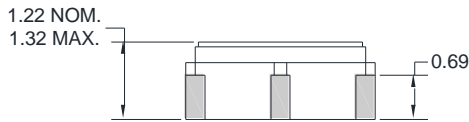
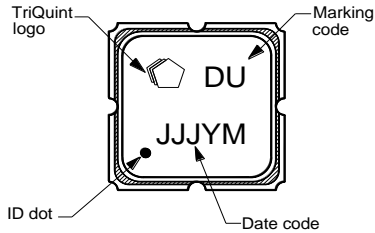

Notes:

1. All dimensions shown are typical in millimeters
2. All tolerances are  $\pm 0.15$ mm except overall length and width  $\pm 0.10$ mm
3. An asterisk (\*) in front of the marking code indicates prototype.

**Tape and Reel information**

Standard T/R size = 5000 units/reel. All dimensions are in millimeters

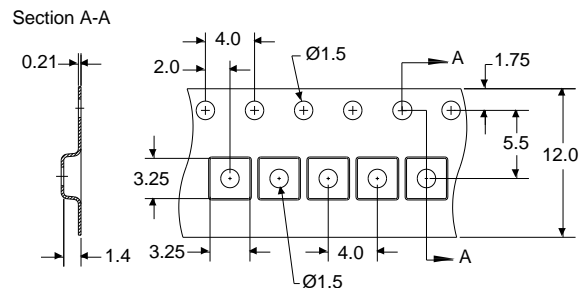
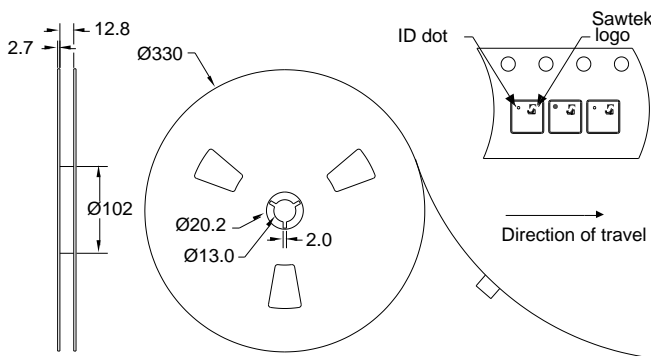

## Product Compliance Information

### ESD Sensitivity Ratings



Caution! ESD-Sensitive Device

ESD Rating: Class 0A  
Value: Passes  $\leq 100$  V  
Test: Electrostatic Discharge Sensitivity Testing,  
Human Body Model (HBM) - component level  
Standard: ESDA/JEDEC JS-001-2012

ESD Rating: Class A  
Value: Passes  $\leq 50$  V  
Test: Machine Model (MM)  
Standard: JEDEC Standard JESD22-A115

### MSL Rating

Not applicable. Hermetic package.

### Solderability

Compatible with both lead-free (260°C maximum reflow temperature) and tin/lead (245°C maximum reflow temperature) soldering processes.

Refer to [Soldering Profile](#) for recommended guidelines.

### RoHS Compliance

This part is compliant with EU 2002/95/EC RoHS directive (Restrictions on the Use of Certain Hazardous Substances in Electrical and Electronic Equipment).

This product also has the following attributes:

- Lead Free
- Halogen Free (Chlorine, Bromine)
- Antimony Free
- TBBP-A (C<sub>15</sub>H<sub>12</sub>Br<sub>4</sub>O<sub>2</sub>) Free
- PFOS Free
- SVHC Free

## Contact Information

For the latest specifications, additional product information, worldwide sales and distribution locations, and information about TriQuint:

Web: [www.triquint.com](http://www.triquint.com)  
Email: [info-sales@tqs.com](mailto:info-sales@tqs.com)

Tel: +1.407.886.8860  
Fax: +1.407.886.7061

For technical questions and application information:

Email: [flapplication.engineering@tqs.com](mailto:flapplication.engineering@tqs.com)

## Important Notice

The information contained herein is believed to be reliable. TriQuint makes no warranties regarding the information contained herein. TriQuint assumes no responsibility or liability whatsoever for any of the information contained herein. TriQuint assumes no responsibility or liability whatsoever for the use of the information contained herein. The information contained herein is provided "AS IS, WHERE IS" and with all faults, and the entire risk associated with such information is entirely with the user. All information contained herein is subject to change without notice. Customers should obtain and verify the latest relevant information before placing orders for TriQuint products. The information contained herein or any use of such information does not grant, explicitly or implicitly, to any party any patent rights, licenses, or any other intellectual property rights, whether with regard to such information itself or anything described by such information.

TriQuint products are not warranted or authorized for use as critical components in medical, life-saving, or life-sustaining applications, or other applications where a failure would reasonably be expected to cause severe personal injury or death.