

**SF2079D**

**251.045 MHz  
SAW Filter**

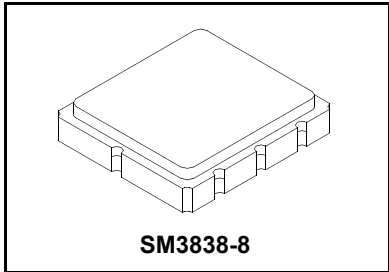

- Precision UHF SAW Filter
- 3.8 X 3.8 mm Surface-mount Case
- Single-ended Input and Output
- Complies with Directive 2002/95/EC (RoHS)



**Absolute Maximum Ratings**

Rating	Value	Units
Maximum Incident Power in Passband	+13	dBm
Maximum DC Voltage Between any Two Terminals	30	VDC
Storage Temperature Range in Tape and Reel	-40 to +85	°C
Suitable for lead-free soldering - Maximum Soldering Temperature	260 °C for 30 s	

**Electrical Characteristics**

Characteristic	Sym	Notes	Min	Typ	Max	Units
Nominal Center Frequency	$f_c$	1		251.045		MHz
Insertion Loss		1		15.5	17.5	dB
Amplitude Ripple:						
(fc-6.2500) to (fc-4.3925) MHz				0.7	1.5	dB <sub>p-p</sub>
(fc-4.3925) to (fc-2.535) MHz				0.5	1.5	
(fc-2.5350) to (fc-0.0250) MHz				0.8	1.5	
(fc+0.0250) to (fc+2.5350) MHz				0.9	1.5	
(fc+2.5350) to (fc+4.3925) MHz				0.5	1.5	
(fc+4.3925) to (fc+6.250) MHz				0.6	1.5	
1.5 dB Bandwidth				13.9		MHz
3.0 dB Bandwidth				14.5		MHz
Low side attenuation below (fc-16.5) MHz			33	37		dB
Low side attenuation between (fc-16.5) and (fc-10.5) MHz			28	32		
High side attenuation between (fc+9.0) and (fc+16.5) MHz			24	30		
High side attenuation above (fc+16.5) MHz			35	40		
Temperature Coefficient of frequency					-18	ppm/K
Group Delay Ripple:						
(fc-6.2500) to (fc-4.3925) MHz				45	70	ns <sub>p-p</sub>
(fc-4.3925) to (fc-2.5350) MHz				25	70	
(fc-2.5350) to (fc-0.0250) MHz				20	90	
(fc+0.0250) to (fc+2.5350) MHz				15	90	
(fc+2.5350) to (fc+4.3925) MHz				25	70	
(fc+4.3925) to (fc+6.2500) MHz				45	90	
Terminating Source / Load Impedance: $Z_{IN} / Z_{OUT}$				150		ohms
Operating Temperature Range			-40		+85	°C
Case Style			SM3838-8 3.8 x 3.8 mm Nominal Footprint			
Lid Symbolization, Y=year, WW=week, S=shift			RFM B44 YWWS			

**CAUTION: Electrostatic Sensitive Device. Observe precautions for handling.**

- NOTES:**
1. Unless noted otherwise, all specifications apply over the operating temperature range with filter soldered to the specified demonstration board with impedance matching to 50 Ω and measured with 50 Ω network analyzer.
  2. Rejection is measured as attenuation below the minimum IL point in the passband. Rejection in final user application is dependent on PCB layout and external impedance matching design. See Application Note No. 42 for details.
  3. The design, manufacturing process, and specifications of this filter are subject to change.
  4. Tape and Reel Standard ANSI / EIA 481.
  5. Either Port 1 or Port 2 may be used for either input or output in the design. However, impedances and impedance matching may vary between Port 1 and Port 2, so that the filter must always be installed in one direction per the circuit design.
  6. US and international patents may apply.
  7. Murata, stylized Murata logo, and Murata N.A., Inc. are registered trademarks of Murata Manufacturing Co., Ltd.

# Filter Response Plots

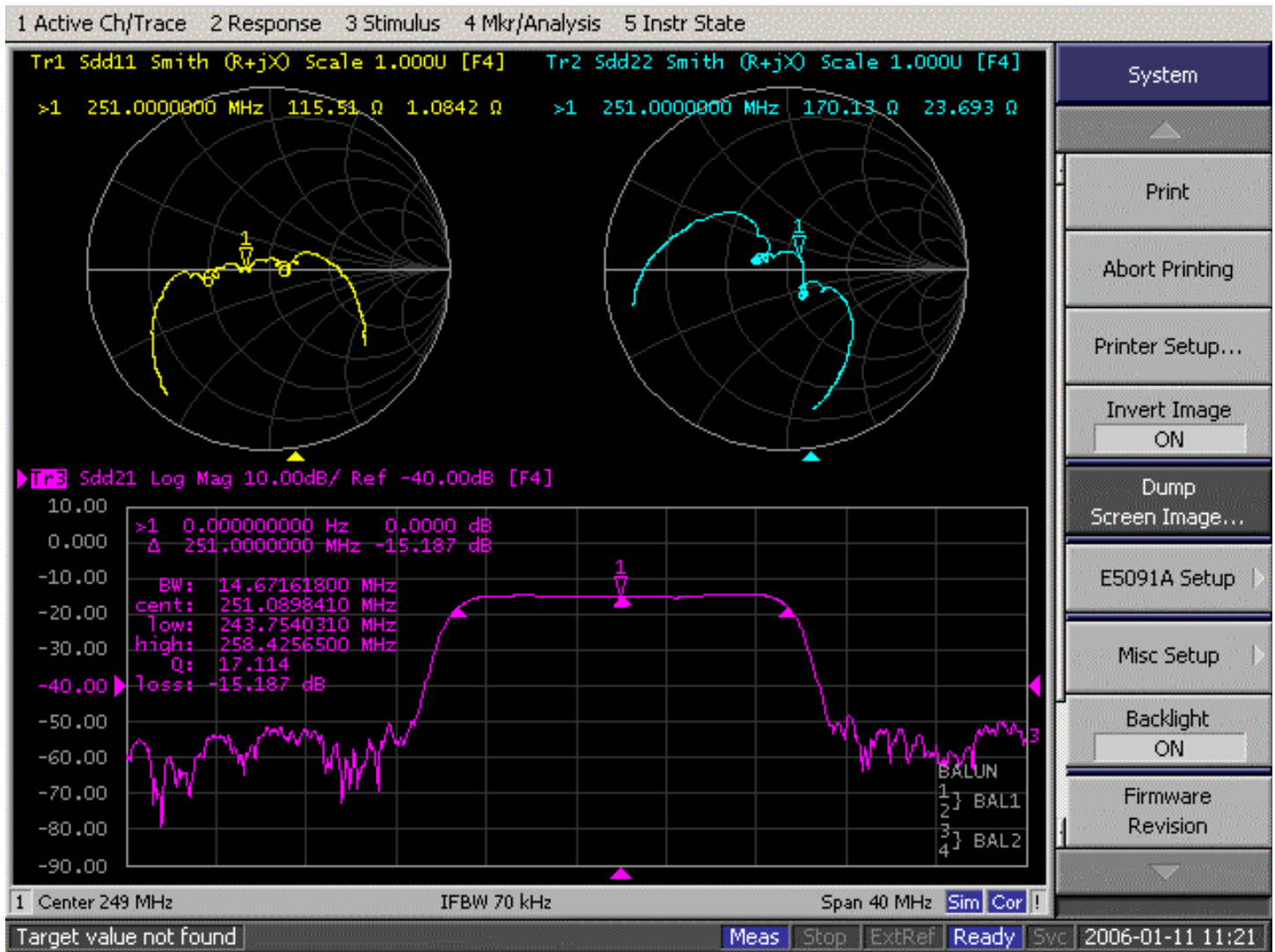

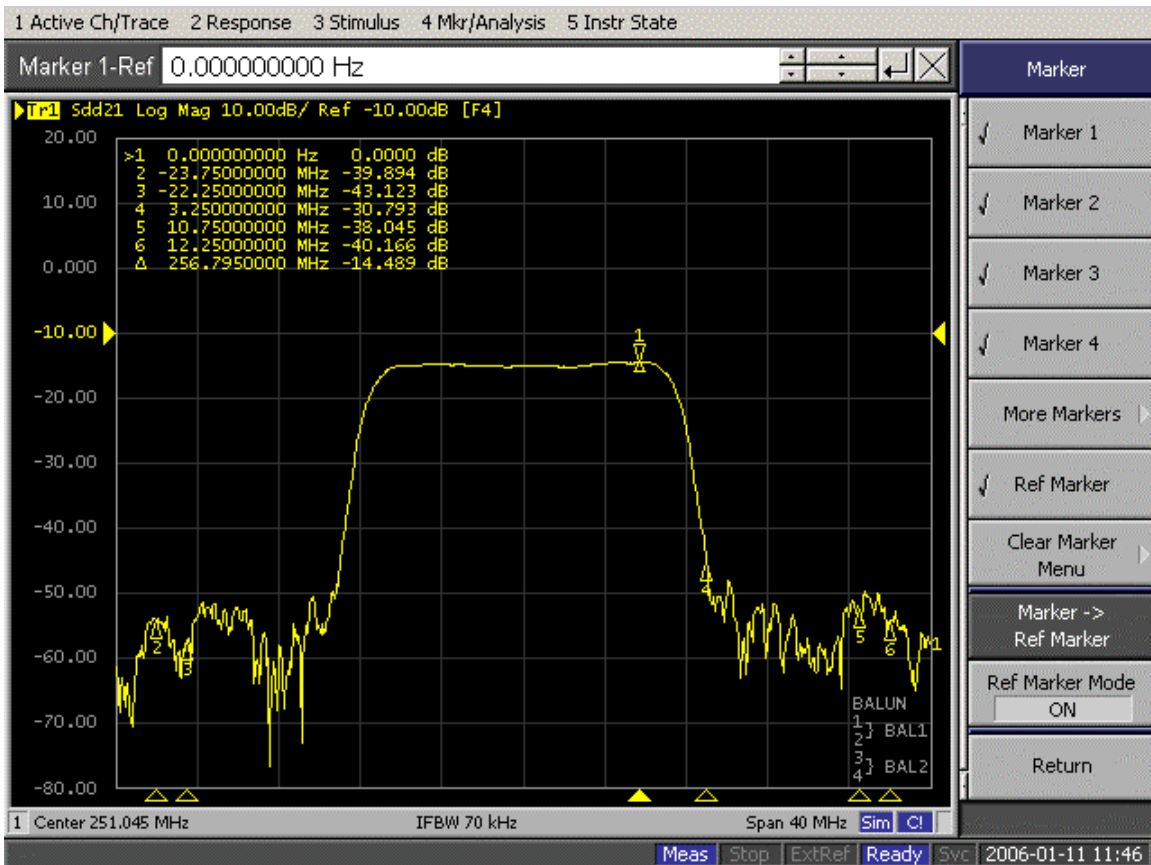
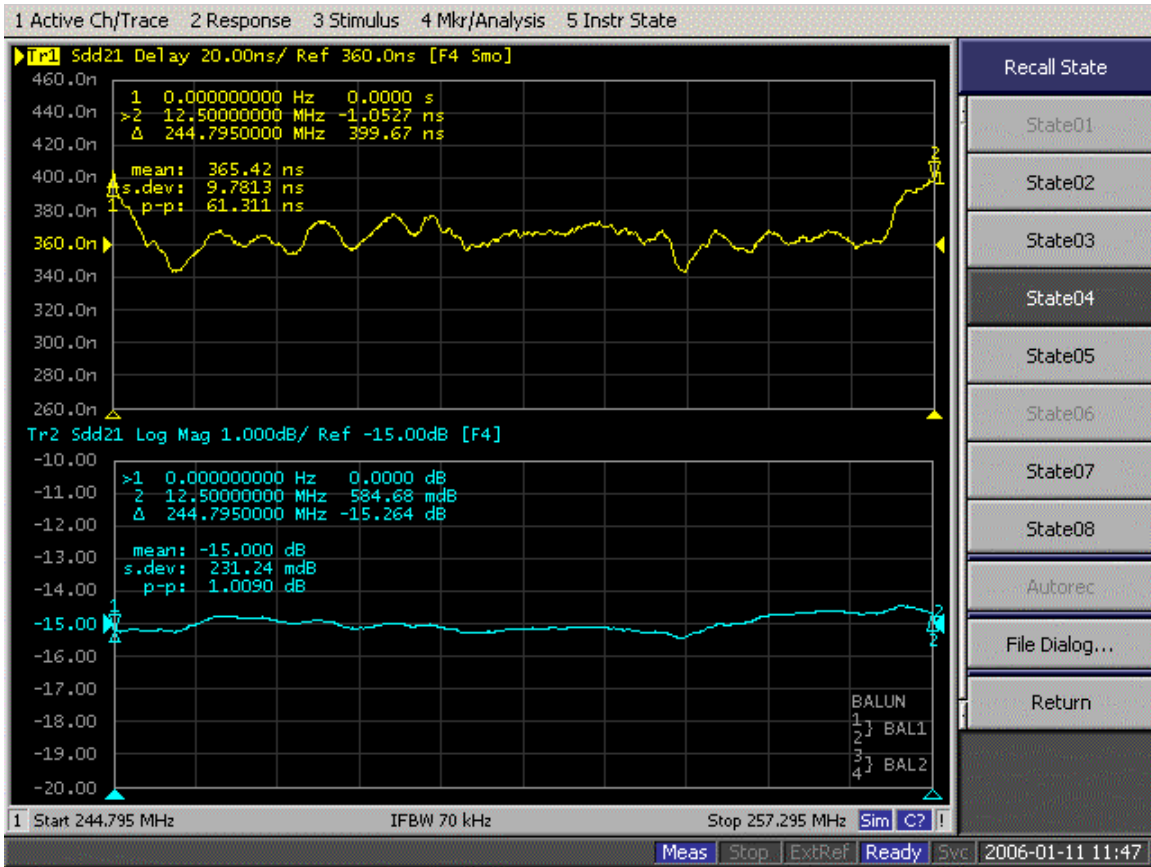

# SM3838-8 Case

## 8-Terminal Ceramic Surface-Mount Case

### 3.8 X 3.8 mm Nominal Footprint

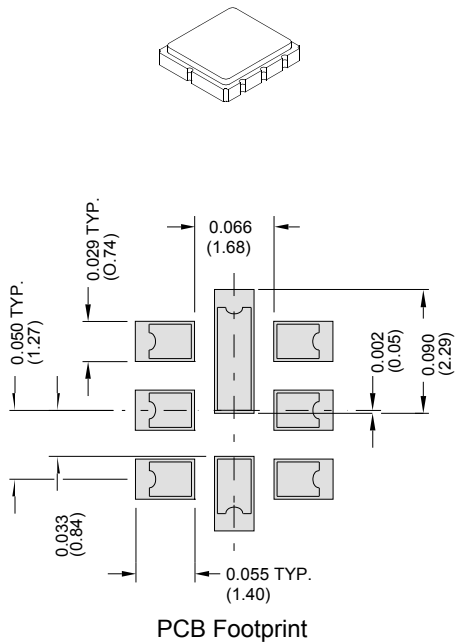

Case Dimensions						
Dimension	mm			Inches		
	Min	Nom	Max	Min	Nom	Max
A	3.6	3.8	4.0	0.142	0.150	0.157
B	3.6	3.8	4.0	0.142	0.150	0.157
C	0.95	1.10	1.25	0.037	0.043	0.049
D	0.60	0.85	1.00	0.023	0.033	0.039
E	0.90	1.00	1.10	0.035	0.040	0.043
F	0.50	0.60	0.70	0.020	0.024	0.028
G	2.39	2.54	2.69	0.090	0.100	0.110
H	1.35	1.5	1.65	0.053	0.059	0.065

Electrical Connections		
	Connection	Terminals
Port 1	Differential Input	1, 2
Port 2	Differential Output	5, 6
	Ground	All Others

Dot Indicates Pin 1

Materials	
Solder Pad Plating	0.3 to 1.0 $\mu\text{m}$ Gold over 1.27 to 8.89 $\mu\text{m}$ Nickel
Lid Plating	2.0 to 3.0 $\mu\text{m}$ Nickel
Body	$\text{Al}_2\text{O}_3$ Ceramic
	Pb Free

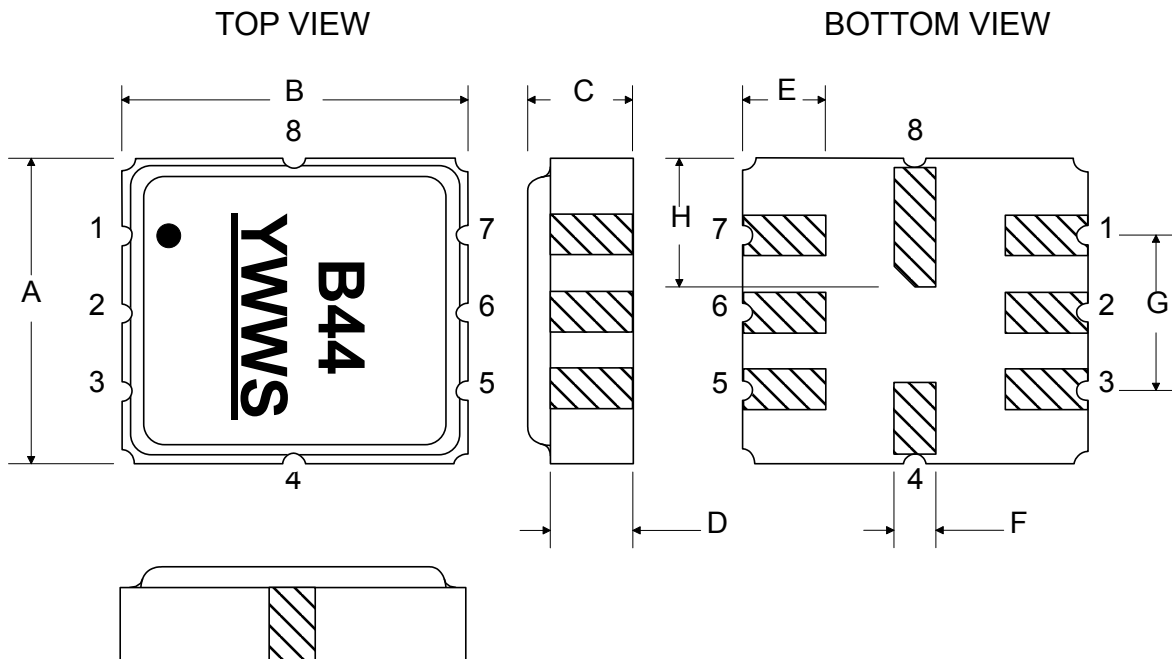

## Tape and Reel Specifications

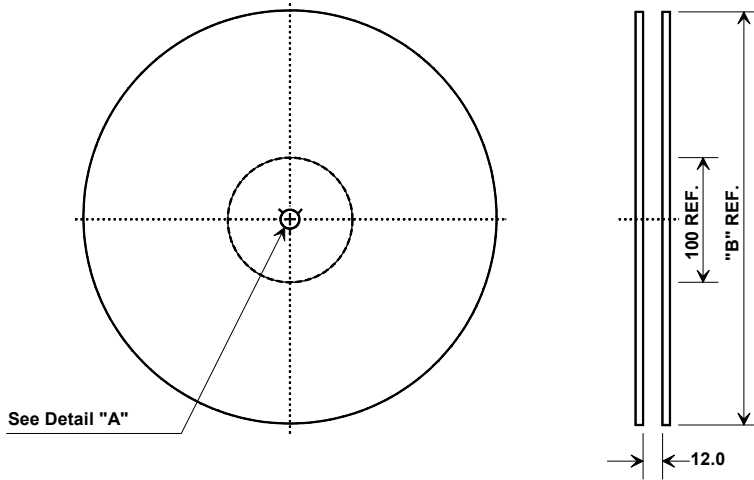

"B" Nominal Size		Quantity Per Reel
Inches	millimeters	
7	178	1000
13	330	3000

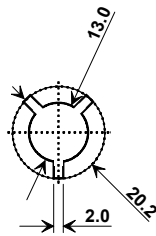

## COMPONENT ORIENTATION and DIMENSIONS

Carrier Tape Dimensions	
Ao	4.25 mm
Bo	4.25 mm
Ko	1.60 mm
Pitch	8.0 mm
W	12.0 mm

