

## Applications

- Band 1 Duplexer for Small cell BTS
- General Purpose Wireless



6 Pin 3.0 x 3.0 mm leadless SMT Package

## Product Features

- 60 MHz Bandwidth
- High Attenuation
- Low Loss
- No External Matching Required
- Small Size: 3.0 x 3.0 x 1.02 mm
- Surface Mount Device
- RoHS Compliant, Pb-Free

## Functional Block Diagram

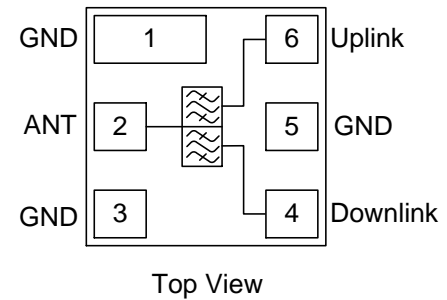

## General Description

The TQQ7101 is an exceptionally high performance BAW duplexer for LTE Band 1. This filter is housed in a compact 3.0 mm x 3.0 mm package for base station applications.

Low insertion loss, coupled with high attenuation makes this filter an ideal choice for small cell BTS needs.

The TQQ7101 is part of Qorvo's extensive portfolio of RF BAW and SAW filters.

## Pin Configuration

Pin No.	Label
2	ANT
4	Downlink
6	Uplink
1, 3, 5	GND

## Ordering Information

Part No.	Description
TQQ7101	Band 1 Duplexer
TQQ7101-EVB	Evaluation Board

Standard T/R size = 2500 pieces on a 7" reel

### Absolute Maximum Ratings

Parameter	Rating
Storage Temperature	-40 to +85°C
RF Input Power DL (LTE, 5MHz, PAR=8 dB)	+29 dBm
RF Input Power UL (CW)	+23 dBm
Maximum DC Voltage on RF Input Pins	+5V

Operation of this device outside the parameter ranges given may cause permanent damage

### Recommended Operating Conditions

Parameter	Min	Typ	Max	Units
T <sub>CASE</sub>	-20		+85	°C

Electrical specifications are measured at specified test conditions.

### Electrical Specifications – Downlink <sup>(1)</sup>

Operating Temperature Range: -20 to +85 °C

Parameter	Conditions	Min	Typ	Max	Units
Passband		2110	-	2170	MHz
Insertion Loss <sup>(2)</sup>	2110 – 2170 MHz	-	2.8	3.8	dB
Amplitude Variation	2110 – 2170 MHz (+25 °C)	-	1.2	2.0	dB
Return Loss <sup>(2)</sup>	Antenna Port	7.1	10.2	-	dB
Return Loss <sup>(2)</sup>	Downlink Port	7.7	10.8	-	dB
Attenuation	0.009 – 1920 MHz	36	37	-	dB
	1920 – 1980 MHz	44	47	-	
	1980 – 2025 MHz	36	40	-	
	2025 – 2070 MHz	37	40	-	
	2210 – 2300 MHz	22	47	-	
	2300 – 2370 MHz	48	51	-	
	2370 – 2484 MHz	44	45	-	
	2484 – 2690 MHz	41	42	-	
	2690 – 3400 MHz	35	38	-	
	3400 – 4200 MHz	24	26	-	
4200 – 4400 MHz	35	39	-		
5150 – 5850 MHz	32	34	-		
Harmonic Distortion <sup>(3)</sup>	Pin = +29 dBm	50	55	-	dBc
Channel Power	LTE 5 MHz, PAR = 8dB, 8 years, 85 °C	+29	-	-	dBm

Notes:

1. All specifications are based on the TriQuint schematic for the main reference design.
2. Average value over the indicated band.
3. Additional 2nd harmonic improvement can be achieved using appropriate application. Refer to product technical notes for details.

## Electrical Specifications – Uplink <sup>(1)</sup>

Operating Temperature Range: -20 to +85 °C

Parameter	Conditions	Min	Typ	Max	Units
Passband		1920		1980	dB
Insertion Loss <sup>(2)</sup>	1920 – 1980 MHz	-	3.1	3.7	dB
Amplitude Variation	1920 – 1980 MHz (+25 °C)	-	1.3	1.9	dB
Return Loss <sup>(2)</sup>	Antenna Port	8.0	10.4	-	dB
Return Loss <sup>(2)</sup>	Uplink Port	7.3	8.6	-	dB
Attenuation	0.009 – 1880 MHz	37	38	-	dB
	1880 – 1900 MHz	34	44	-	
	2000 – 2010 MHz	4	21	-	
	2010 – 2110 MHz	33	37	-	
	2110 – 2690 MHz	38	39	-	
	2690 – 3400 MHz	32	36	-	
	3400 – 3800 MHz	34	35	-	
3800 – 5850 MHz	18	21	-		
Channel Power	CW, 8 years, 85 °C	+23	-	-	dBm

Notes:

1. All specifications are based on the TriQuint schematic for the main reference design.
2. Average value over the indicated band.

## Electrical Specifications – Isolation Uplink to Downlink <sup>(1)</sup>

Operating Temperature Range: -20 to +85 °C

Parameter	Conditions	Min	Typ	Max	Units
Isolation in Uplink <sup>(2)</sup>	1920 – 1980 MHz	48	51	-	dB
Isolation in Downlink <sup>(2)</sup>	2110 – 2170 MHz	39	42	-	dB

Notes:

1. All specifications are based on the TriQuint schematic for the main reference design.
2. Average value over the indicated band.

**TQQ7101-PCB Evaluation Board**

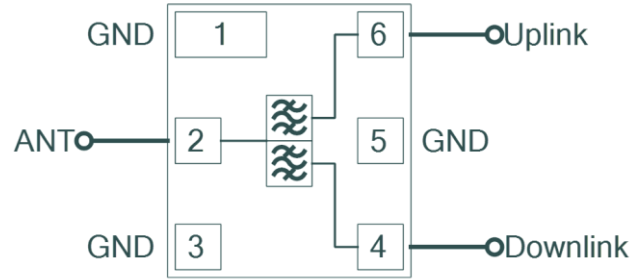
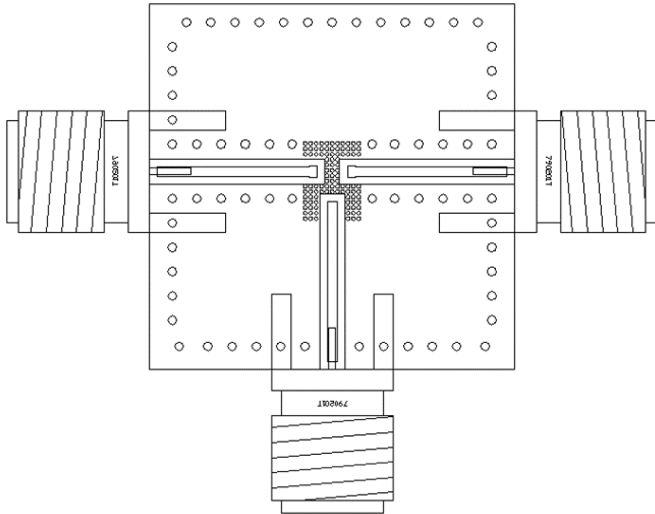

**Bill of Material – TQQ7101-PCB**

Reference Des.	Value	Description	Manuf.	Part Number
U1	n/a	Band 1 BAW Duplexer	Qorvo	TQQ7101
n/a	n/a	Printed Circuit Board	Qorvo	1039708
n/a	n/a	SMA Edge Connector		1041120

**Performance Plots – Downlink**

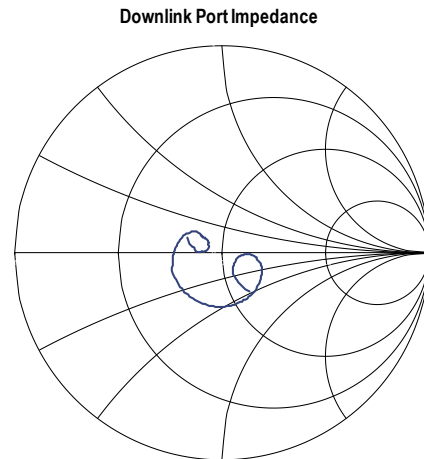
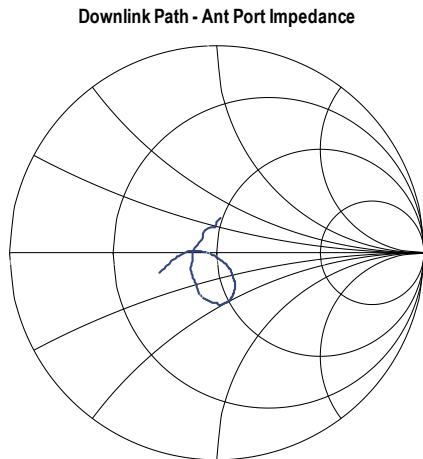
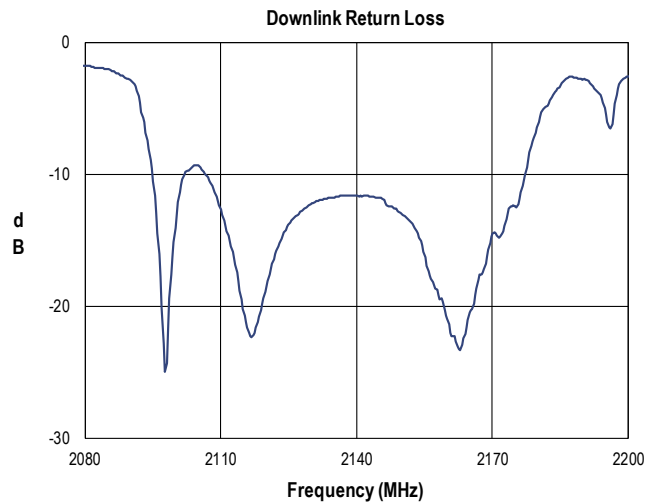
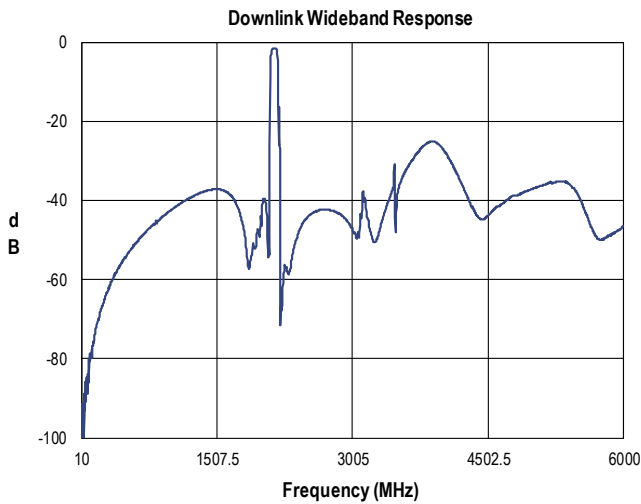
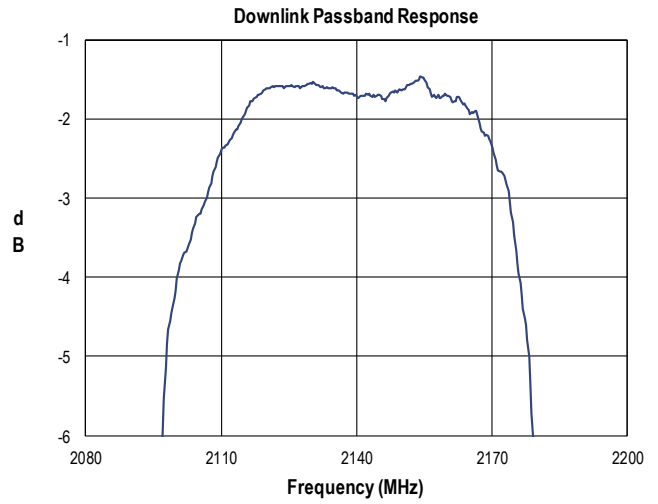
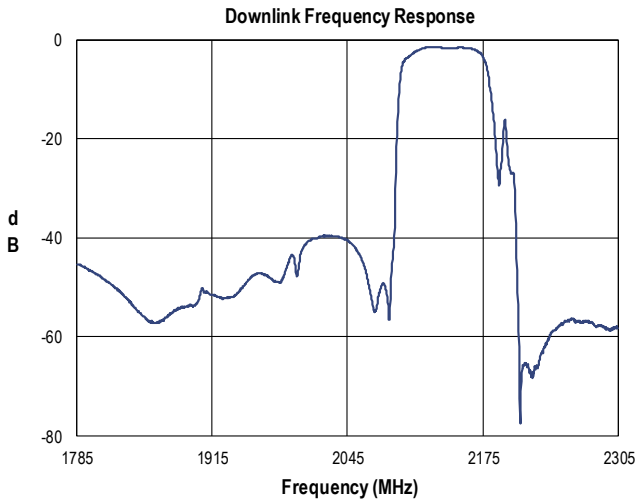

**Performance Plots – Uplink**

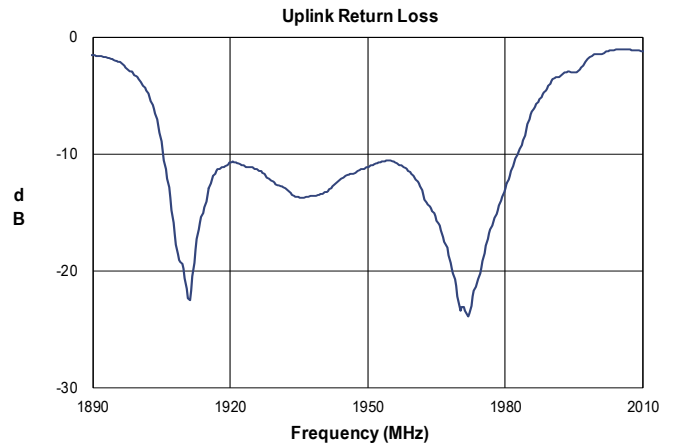
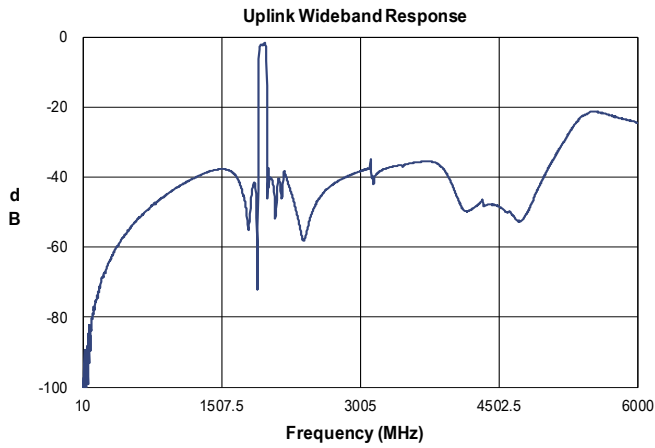
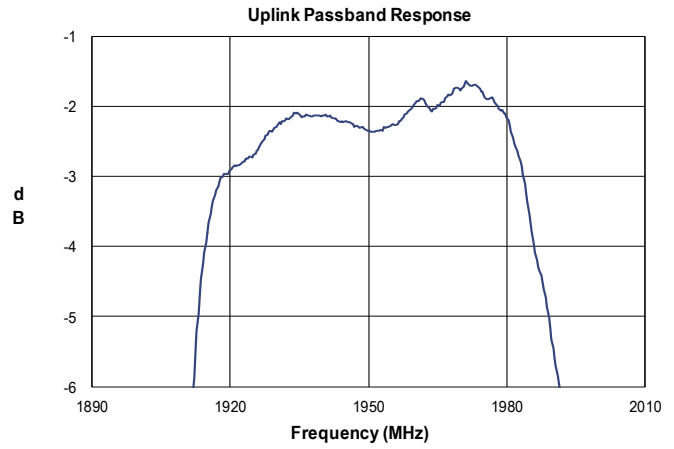
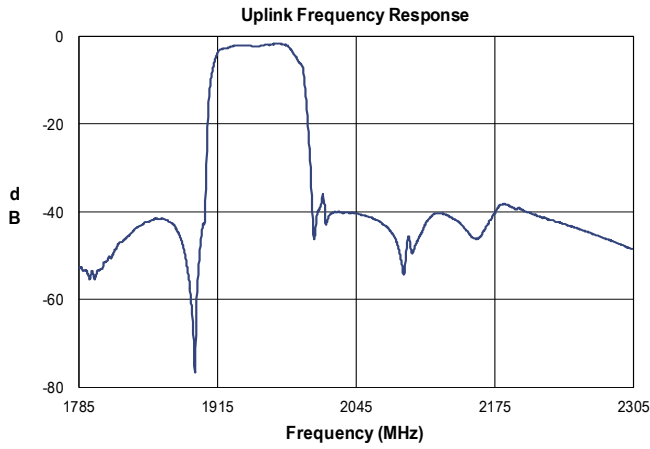

**Uplink Path - Ant Port Impedance**

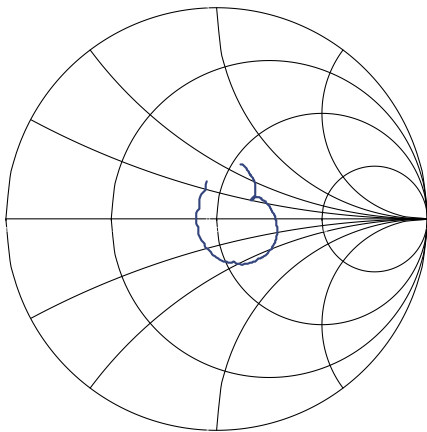

**Uplink Port Impedance**

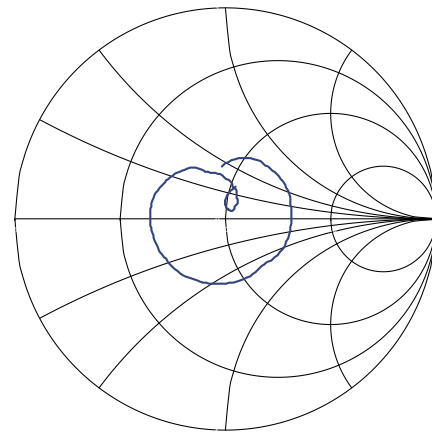

**Performance Plots (cont'd)**

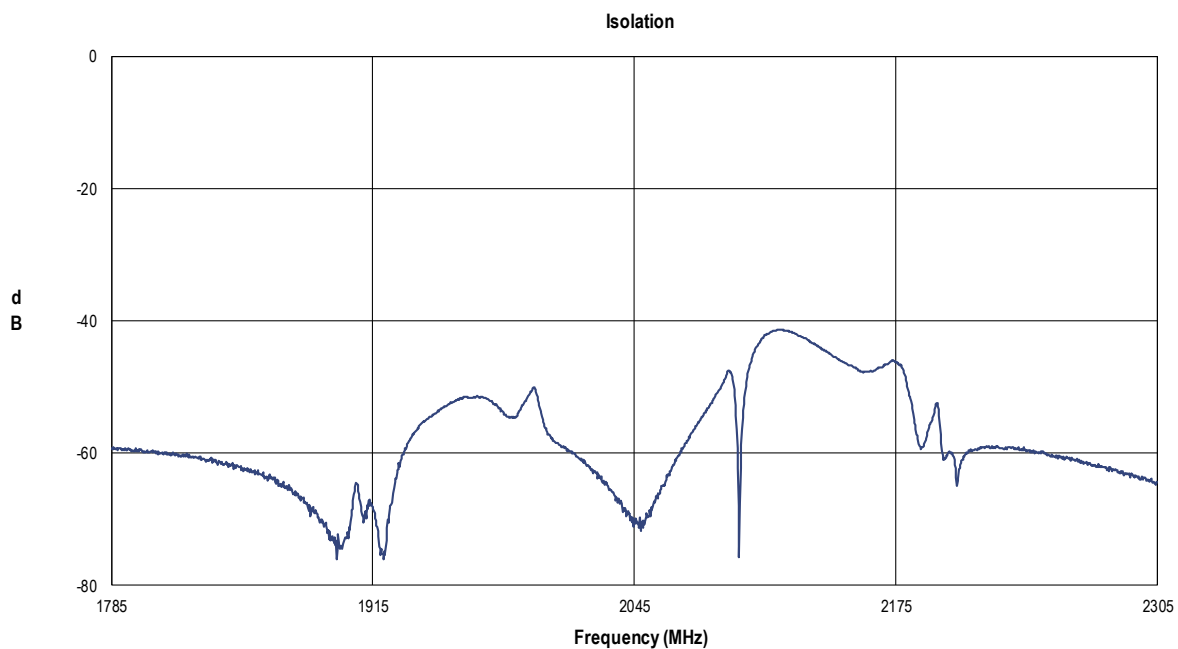
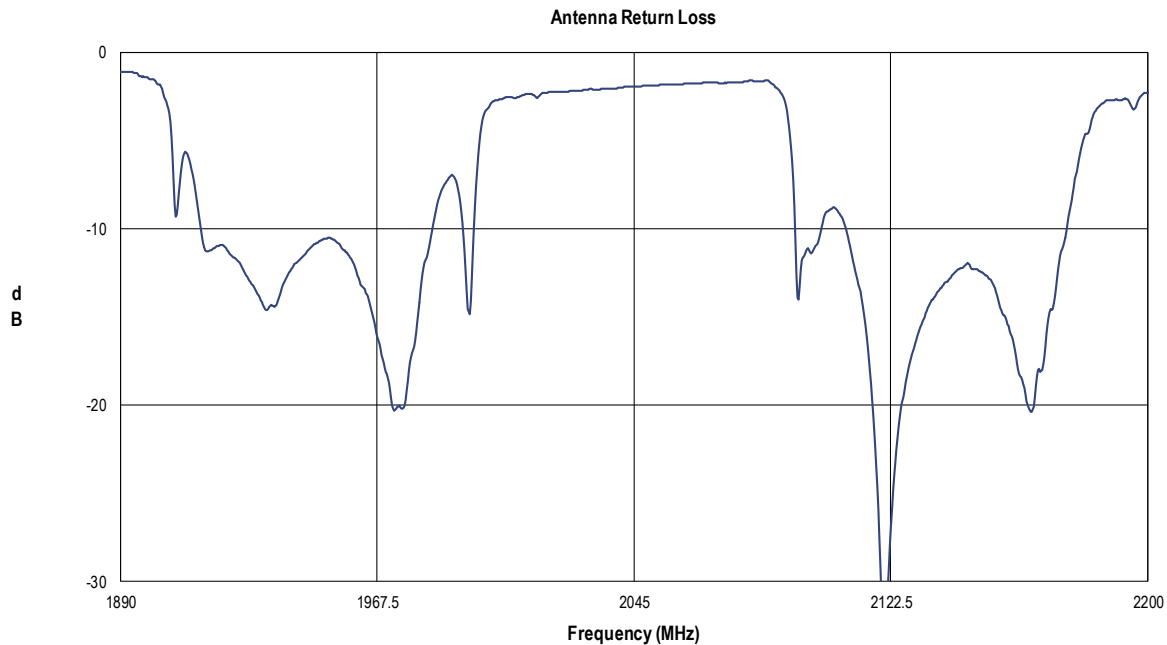

**Package Marking and Dimensions**

**Package Marking**

Product Identifier: Q7103  
 Date Code: YYWW  
 Assembly Code: aXXXX

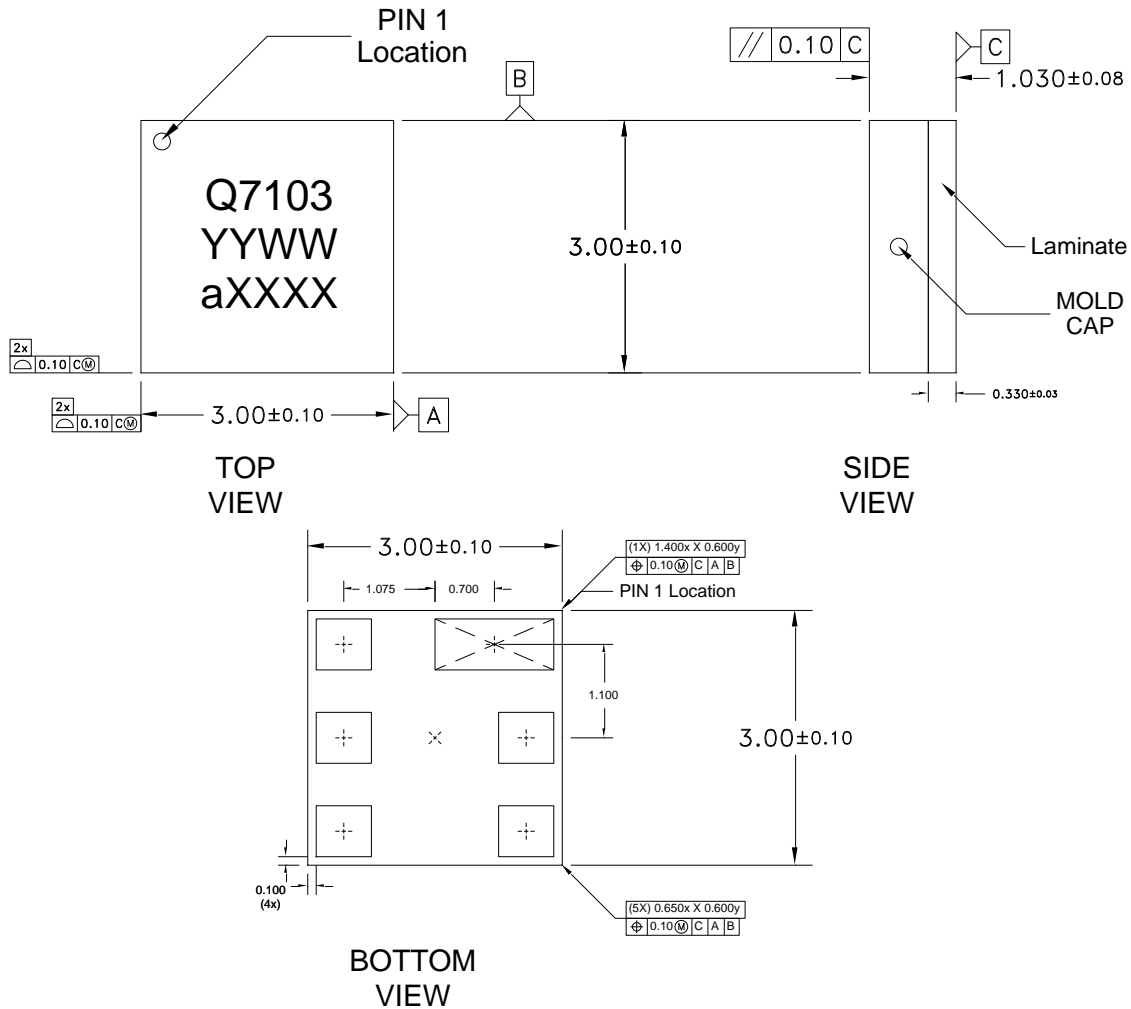

**Notes:**

1. All dimensions are in millimeters. Angles are in degrees.
2. Dimension and tolerance formats conform to ASME Y14.4M-1994.
3. The terminal #1 identifier and terminal numbering conform to JESD 95-1 SPP-012.



**PCB Mounting Pattern**

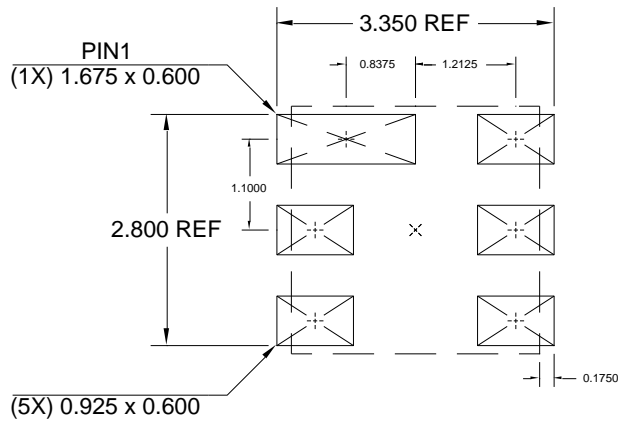

**RECOMMENDED  
LAND PATTERN**

Top view recommended land pattern metallization.

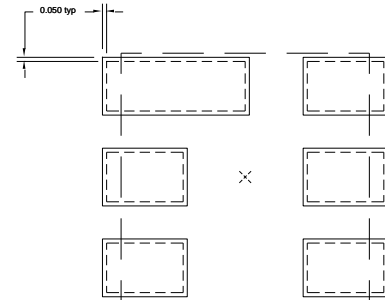

**RECOMMENDED  
LAND PATTERN MASK**

Top view recommended land pattern stencil aperture.

**Notes:**

1. All dimensions are in millimeters. Angles are in degrees.
2. Use 1 oz. copper minimum for top and bottom layer metal.

**Tape and Reel Information – Carrier and Cover Tape Dimensions**

Tape and reel specifications for this part are also available on the TriQuint website.  
Standard T/R size = 2500 pieces on a 7” reel.

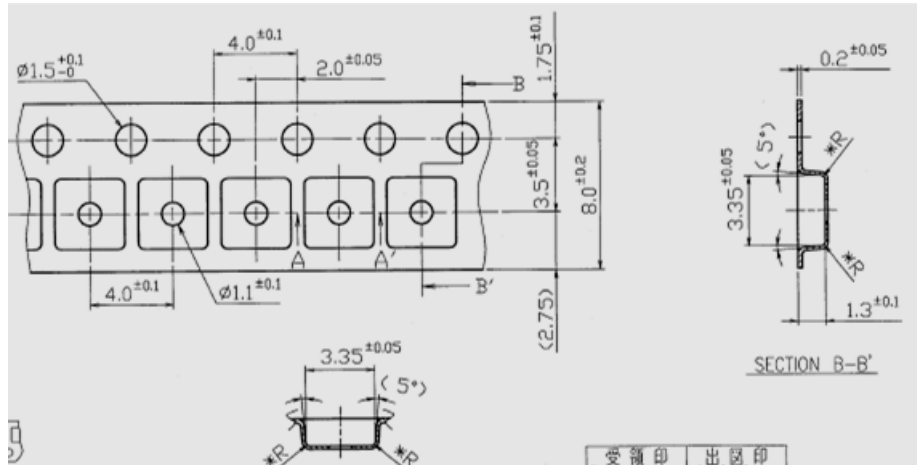

Feature	Measure	Symbol	Size (in)	Size (mm)
Cavity	Length	A0	0.132	3.35
	Width	B0	0.132	3.35
	Depth	K0	0.055	1.40
	Pitch	P1	0.157	4.00
Centerline Distance	Cavity to Perforation - Length Direction	P2	0.079	2.00
	Cavity to Perforation - Width Direction	F	0.138	3.50
Cover Tape	Width	C	0.213	5.40
Carrier Tape	Width	W	0.315	8.00

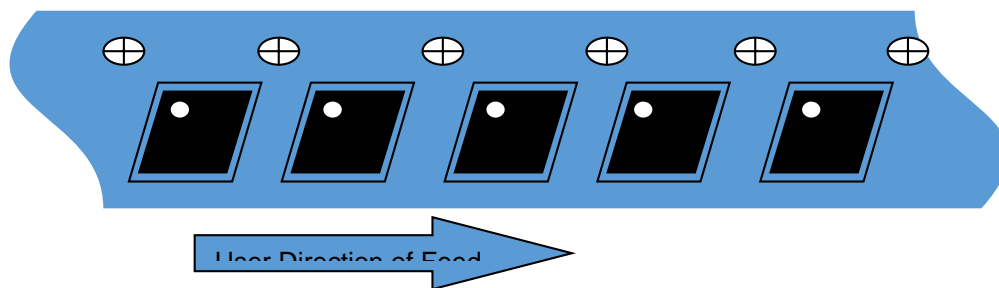

**Tape and Reel Information – Reel Dimensions**

Tape and reel specifications for this part are also available on the TriQuint website.  
Standard T/R size = 2,500 pieces on a 7" reel.

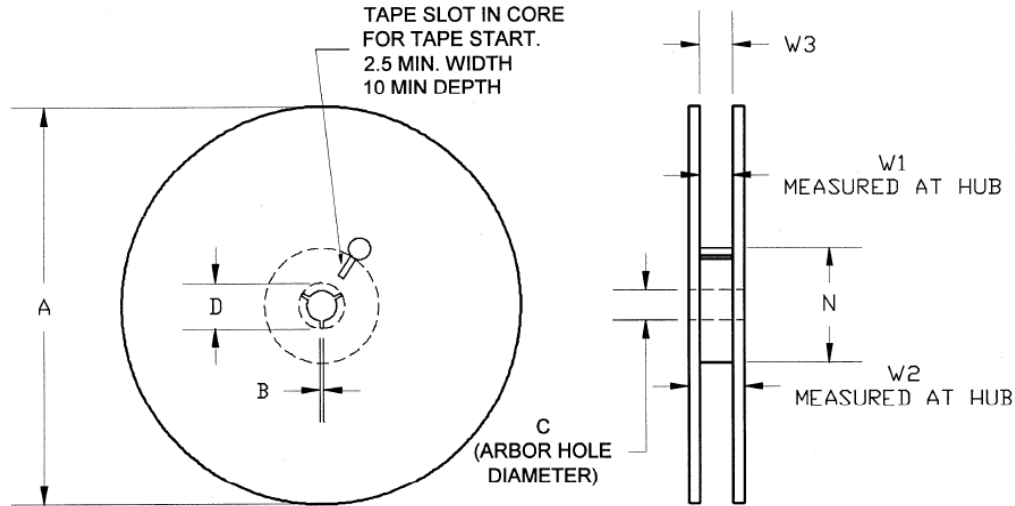

Feature	Measure	Symbol	Size (in)	Size (mm)
Flange	Diameter	A	6.969	177.0
	Thickness	W2	0.559	14.2
	Space Between Flange	W1	0.346	8.8
Hub	Outer Diameter	N	2.283	58.0
	Arbor Hole Diameter	C	0.512	13.0
	Key Slit Width	B	0.079	2.0
	Key Slit Diameter	D	0.787	20.0

## Product Compliance Information

### ESD Sensitivity Ratings



Caution! ESD-Sensitive Device

ESD Rating: Class 0B  
Value:  $\geq 125$  V to  $< 250$  V  
Test: Human Body Model (HBM)  
Standard: ESDA / JEDEC Standard JS-001-2012

ESD Rating: Class B  
Value:  $> 200$  V to  $< 400$  V  
Test: Machine Model (MM)  
Standard: JEDEC Standard JESD22-A115

### MSL Rating

MSL Rating: Level 3  
Test: 260°C convection reflow  
Standard: JEDEC Standard IPC/JEDEC J-STD-020

### Solderability

Compatible with both lead-free (+260 °C maximum reflow temperature) and tin/lead (+245 °C maximum reflow temperature) soldering processes.

Contact plating: ENIG (Electroless Nickel Immersion Gold)

Refer to [Soldering Profile](#) for recommended guidelines.

### RoHS Compliance

This part is compliant with EU 2002/95/EC RoHS directive (Restrictions on the Use of Certain Hazardous Substances in Electrical and Electronic Equipment).

This product also has the following attributes:

- Lead Free
- Halogen Free (Chlorine, Bromine)
- Antimony Free
- TBBP-A (C<sub>15</sub>H<sub>12</sub>Br<sub>4</sub>O<sub>2</sub>) Free
- PFOS Free
- SVHC Free

## Contact Information

For the latest specifications, additional product information, worldwide sales and distribution locations, and information about TriQuint:

**Web:** [www.triquint.com](http://www.triquint.com)  
**Email:** [customer.support@qorvo.com](mailto:customer.support@qorvo.com)

**Tel:** 877-800-8584

For information about the merger of RFMD and TriQuint as Qorvo:

**Web:** [www.qorvo.com](http://www.qorvo.com)

## Important Notice

The information contained herein is believed to be reliable. TriQuint makes no warranties regarding the information contained herein. TriQuint assumes no responsibility or liability whatsoever for any of the information contained herein. TriQuint assumes no responsibility or liability whatsoever for the use of the information contained herein. The information contained herein is provided "AS IS, WHERE IS" and with all faults, and the entire risk associated with such information is entirely with the user. All information contained herein is subject to change without notice. Customers should obtain and verify the latest relevant information before placing orders for TriQuint products. The information contained herein or any use of such information does not grant, explicitly or implicitly, to any party any patent rights, licenses, or any other intellectual property rights, whether with regard to such information itself or anything described by such information.

TriQuint products are not warranted or authorized for use as critical components in medical, life-saving, or life-sustaining applications, or other applications where a failure would reasonably be expected to cause severe personal injury or death.